



# **ASI385 Manual**

Revision 1.2

Aug, 2021

All materials related to this publication are subject to change without notice and its copyright totally belongs to Suzhou ZWO CO.,LTD.



---

ASI385 Manual .....	1
1. Instruction .....	3
2. Camera Models and Sensor Type .....	4
3. What's in the box?.....	5
4. Camera technical specifications.....	6
5. QE Graph & Read Noise.....	7
6. Getting to know your camera.....	9
6.1 External View.....	9
6.2 Power consumption:.....	9
6.3 Cooling system.....	错误!未定义书签。
6.5 Analog to Digital Converter (ADC).....	10
6.6 Binning.....	10
7. How to use your camera.....	11
8. Cleaning .....	13
9. Mechanical drawing.....	14
10. Servicing .....	15
11. Warranty .....	15

# 1. Instruction

Congratulations and thank you for buying one of our ASI Cameras ! This manual will give you a brief introduction to your ASI camera. Please read it thoroughly. If you have any other questions, please feel free to contact us. [info@zwoptical.com](mailto:info@zwoptical.com)

ASI385 Cameras are designed for astronomical photography. Its excellent performance and multifunctional usage will impress you a lot!

For software installation instructions and other technical information please refer to “Support” on our official website.

<https://astronomy-imaging-camera.com/>

## 2. Camera Models and Sensor Type

Model	Mono or Color	Regulated TEC Cooling	Sensor
ASI385MC	Color	No	IMX385
ASI385MC-COOL (Discontinued)	Color	Yes	IMX385

Why do I choose ASI385?

ASI385 cameras are designed for astronomical photography. The slightly larger sensor, extremely low read noise, high sensitivity and high frame rates make this new camera a very good choice for planetary imaging, it also comes with a 2.5mm all sky lens which can provide a nearly 170° view of the sky. The excellent performance and multifunctional usage will impress you a lot!

TEC cooling will help to reduce dark current noise for long exposures. For short exposures, such as under one second, the dark current noise is very low. However, cooling is recommended for DSO imaging when long exposures are required.

### 3. What's in the box?

ASI385MC



Camera body



1.25" Cover



1.25" Nosepiece



ST4 Cable



Quick guide



USB3.0 Cable  
(2m)

## 4. Camera technical specifications

Sensor	1/1.9" CMOS IMX385
Diagonal	8.35mm
Resolution	2.12 Mega Pixels 1936X1096
Pixel Size	3.75 $\mu$ m
Image area	7.3mm*4.1mm
Max FPS at full resolution	120fps (10bitADC)
Shutter	Rolling shutter
Exposure Range	32 $\mu$ s-2000s
Read Noise	0.75e @30db gain
QE peak	>80%
Full well	18.7Ke
ADC	12bit
Interface	USB3.0/USB2.0
Adapters	2" / 1.25" / M42X0.75
Protect window	AR window
Dimensions	62mm
Weight	120g
Back Focus Distance	12.5mm
Supported OS	Windows, Linux & Mac OSX
Working Temperature	-5°C~45°C
Storage Temperature	-20°C~60°C
Working Relative Humidity	20%~80%
Storage Relative Humidity	20%~95%

## 5. QE Graph & Read Noise

QE and Read noise are the most important parts to measure the performance of a camera. Higher QE and Lower read noise are needed to improve the SNR of an image.

Color 385 Sensor Relative QE

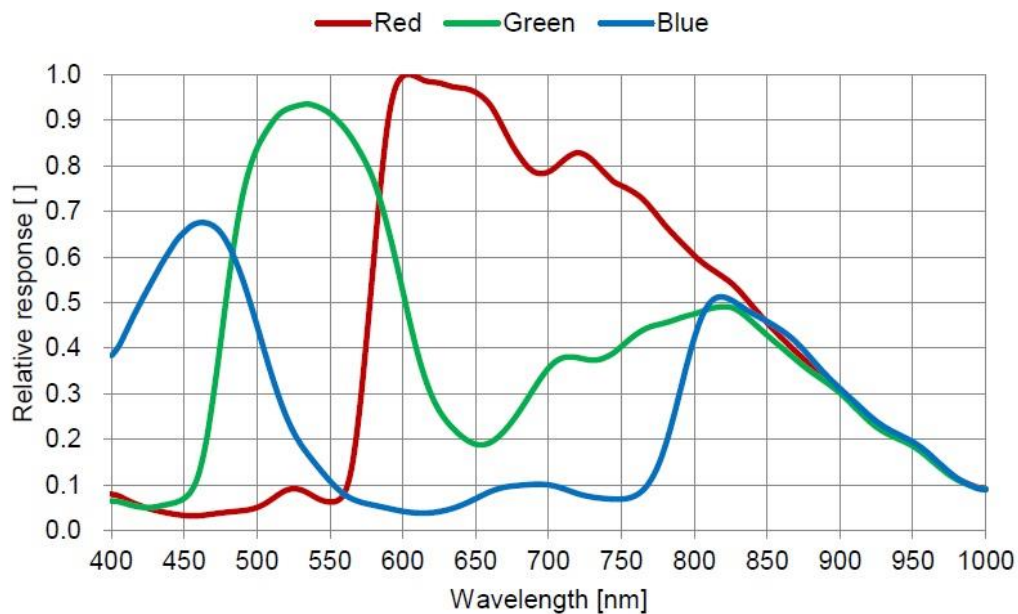

Read Noise includes pixel diode noise, circuit noise and ADC quantization error noise, and the lower the better.

The Read Noise of the ASI385 cameras is extremely lower when compared with traditional CCD cameras. It is even lower when the camera is set at a higher gain.

Depending on your target, you can set the Gain lower for higher Dynamic Range (longer exposure) or set the Gain higher for lower noise (such as short exposure or lucky imaging).

## Read noise, full well, gain and dynamic range for ASI385

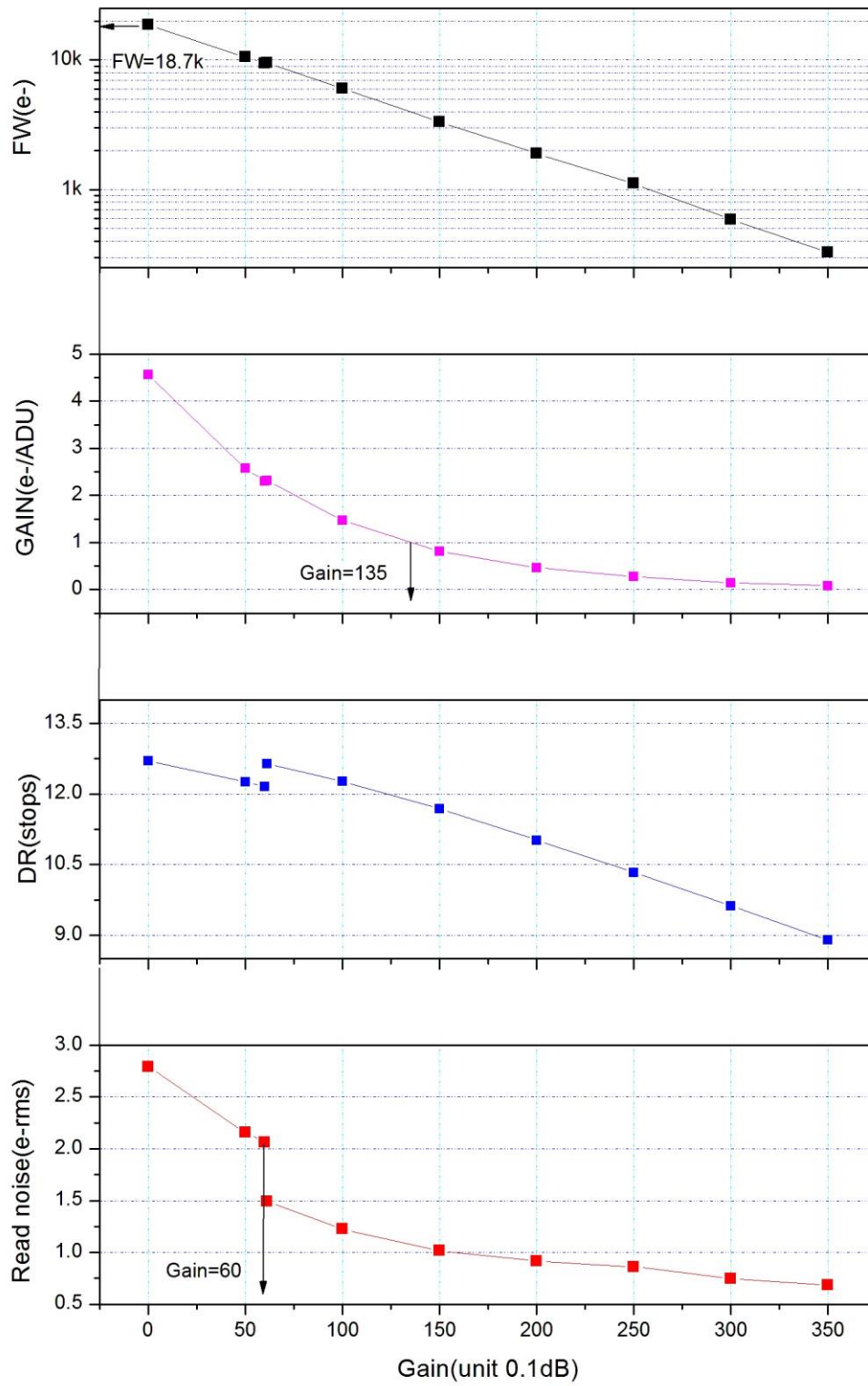



## 6. Getting to know your camera

### 6.1 External View



### 6.2 Power consumption

ASI cameras are designed to have very low power consumption which is around 180ma@5V.  
You only need the USB cable to power up the camera.

### 6.3 Protect Window

Our ASI385MC comes with the D21 AR window, thickness is 1.1 mm  
Transmission chart of the AR filter.

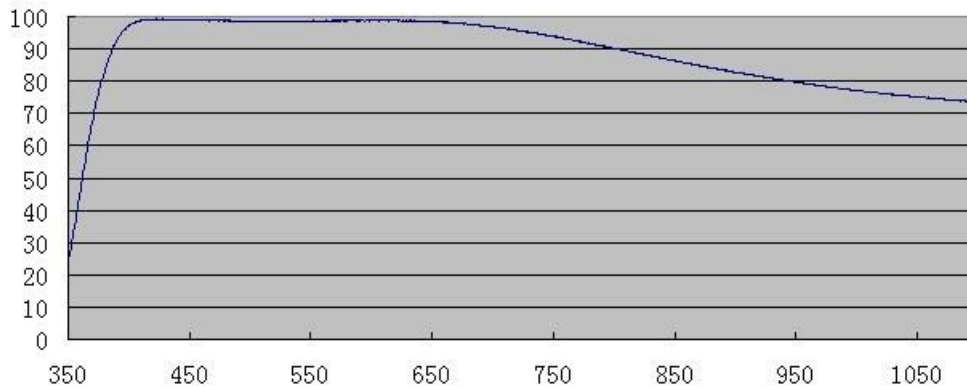

## 6.4 Analog to Digital Converter (ADC)

The ASI385 camera records in 10bit ADC and 12bit ADC. You can image at a faster fps rate if you choose to use 10bit ADC (high speed mode). This camera also supports ROI (region of interest) shooting, and this smaller ROI has faster fps.

Here is the maximum speed of ASI385 running at 10bit ADC and 10bit ADC.

Resolution	USB3.0	
	10Bit ADC	12Bit ADC
1944x1224	108fps	54fps
1920x1080	120fps	60fps
1024x768	170.5fps	85.2fps
800x800	163.8fps	81.9fps
640x480	268.4fps	134.2fps
320x240	515.3fps	257.6fps

## 6.5 Binning

The ASI385 camera supports software bin2 mode. You should use 10bit ADC. We recommend customer to use software binning if you don't care speed.

## 7. How to use your camera

There are many adapters available for this camera for connecting to your scope or lens. Some are included with the camera and others you can order from our site:

Color camera connecting drawing:

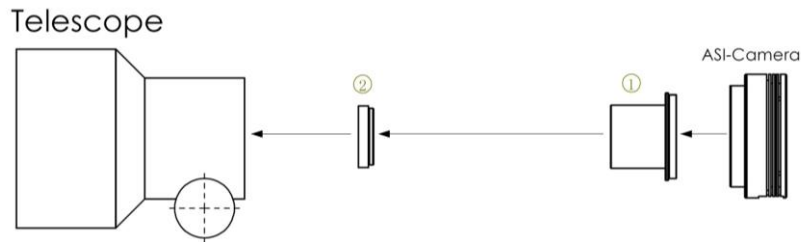

1. 1.25" T-Mount

2. 1.25" filter (optional)

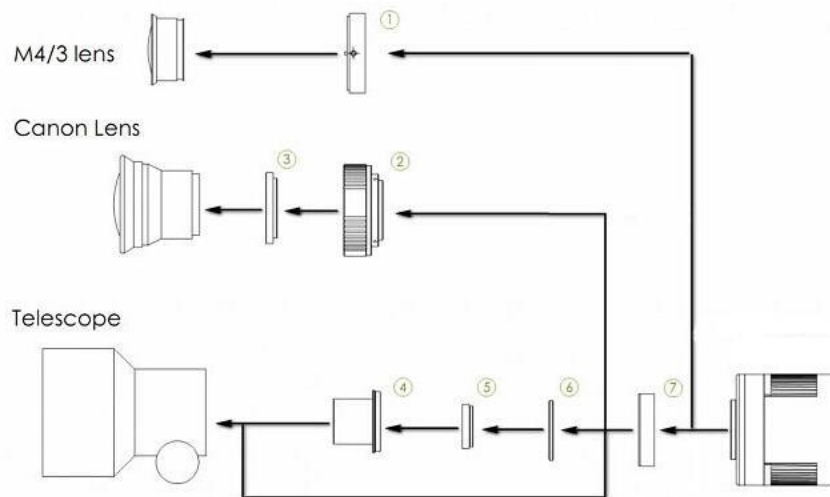

1. M43-T2 adapter

2. EOS-T2 adapter

3. 2" Filter (optional)

4. 1.25" T-Mount

5. 1.25" Filter (optional)

6. M42-1.25" Filter (optional)

7. T2 extender 11mm

Planetary/Guide Cameras  
External Device Connecting Drawing



## 8. Cleaning

The camera comes with an AR protect window, which can protect the sensor from dust and humidity. Should you need to clean the sensor, it's better to do so during the daytime. To see the dust, you just need to setup your telescope and point it to a bright place. A Barlow is required to see these dusts clear. Then attach the camera and adjust the exposure to make sure not over exposed. You can see an image like below if it's dirty.

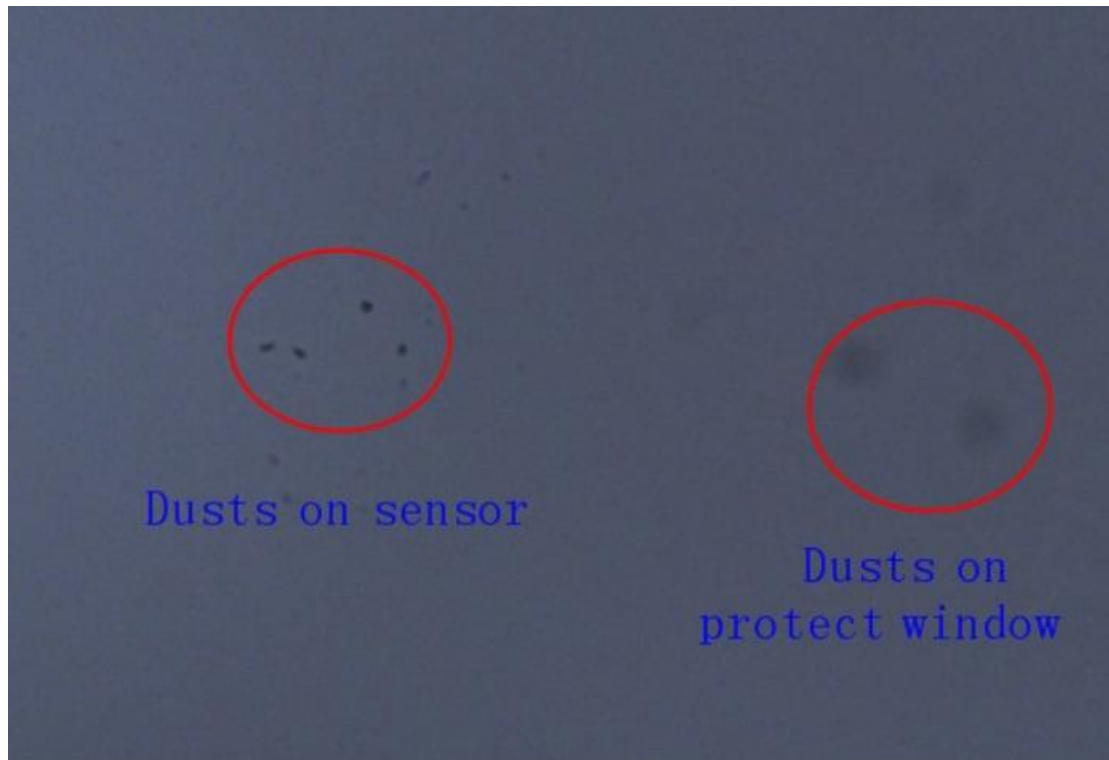

The big dim spot on the image (at right ) are the shadows of dust on the protect window.

The very small but very dark spot in the image (at left) are the shadows of the dusts on the sensor.

The suggested way to clean them is try to blow them away with a manual air pump. To clean the dust on the sensor you will need to open the camera chamber.

We have a very detailed instruction on our website:

<https://astronomy-imaging-camera.com/manuals/How to clean ASI camera and redry the desiccant.pdf>

## 9. Mechanical drawing

ASI385MC

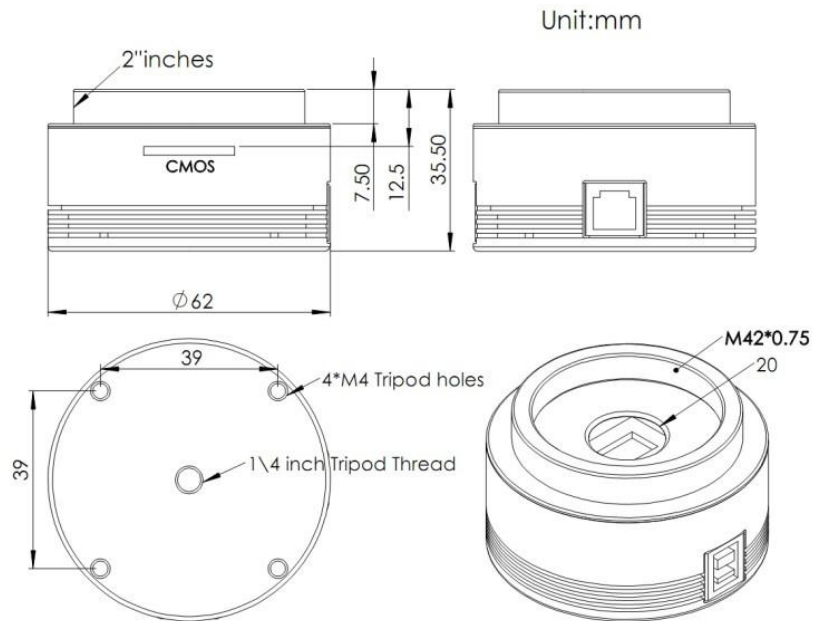

## 10. Servicing

For software upgrades please refer to “Support-manual and software” on our official website.

<https://astronomy-imaging-camera.com/>

For repairs and consultation:

<https://support.astronomy-imaging-camera.com/>

For customers who bought the camera from your local dealer, dealer is responsible for the customer service.

## 11. Warranty

We provide 2-year warranty for our products. We offer repair service or replacement for free if the camera doesn't work within warranty period.

After the warranty period, we continue to provide repair support and service on a charged basis. This warranty does not apply to damage that occurred as a result of abuse or misuse, or caused by a fall or any other transportation failures after purchase.

Customer must pay for shipping when shipping the camera back for repair or replacement.