



# **ASI120 Manual**

Revision 1.4

Aug, 2021

All materials related to this publication are subject to change without notice and its copyright totally belongs to Suzhou ZWO CO.,LTD.



---

ASI120 Manual .....	1
1. Instruction .....	3
2. Camera Models and Sensor Type .....	4
3. What's in the box?.....	5
4. Camera technical specifications.....	6
5. QE Graph & Read Noise.....	7
6. Getting to know your camera.....	9
6.1 External View.....	9
6.2 Protect Window.....	11
6.3 Analog to Digital Converter (ADC).....	12
6.4 Binning.....	12
7. How to use your camera.....	13
8. Clean the camera and redry desiccant.....	14
9. Mechanical drawing.....	15
10. Servicing .....	16
11. Warranty .....	16



# 1. Instruction

Congratulations and thank you for buying one of our ASI Cameras! This manual will give you a brief introduction to your ASI camera. Please read it thoroughly. If you have any other questions, please feel free to submit it on the ZWO support site:

<https://support.astronomy-imaging-camera.com/>

ASI120 camera is an excellent choice for those who has just started to make astronomy photographing with affordable price. Its excellent performance and multifunctional usage will impress you a lot!

For software installation instructions and other technical information please refer to “Support” on our official website.

<https://astronomy-imaging-camera.com/>

## 2. Camera Models and Sensor Type

There are 4 types of ASI120 models:

Models	Mono or Color	Interface	Sensor
<b>ASI120MM (Discontinued)</b>	Mono	USB2.0	AR0130CS
<b>ASI120MC (Discontinued)</b>	Color	USB2.0	AR0130CS
<b>ASI120MM-S</b>	Mono	USB3.0	AR0130CS
<b>ASI120MC-S</b>	Color	USB3.0	AR0130CS

### Why do I choose ASI120?

It is mostly used for planetary imaging. It can also be used for deep sky imaging up to a certain level. This new version comes with an ST4 Auto guider Port, so you may now use it both for imaging and guiding.

Monochrome camera sensors are capable of higher details and sensitivity than color sensors, but you need additional accessories such as filters. The post-processing is more complicated too. So color camera is often recommended for beginner of astrophotographer.

ZWO ASI120-S CMOS Camera follows ASI120. ASI120-S has 3.0 USB port instead of 2.0 port, with faster speed!

### 3. What's in the box?

ASI120MM-S and ASI120MC-S



Camera body



1.25" Cover



1.25" Nosepiece



ST4 Cable



Quick guide



USB3.0 Cable  
(2m)

## 4. Camera technical specifications

Sensor	1/3" CMOS AR0130CS
Resolution	1.2Mega Pixels 1280×960
Pixel Size	3.75μm
Max FPS at full resolution	ASI120MM-S/MC-S 60FPS(12bitADC)
Shutter	Rolling shutter
Exposure Range	64μs-2000s
Read Noise	4.0e~6.6e
QE peak	Almost 80%
ADC	12 bit
Interface	USB3.0(ASI120MM-S/MC-S)
Adapters	2" / 1.25" / M42X0.75
Back focus distance	12.5mm
Dimensions	62mm
Weight	100g
Supported OS	Windows, Linux & Mac OSX
Power consumption	150ma@5V (ASI120MM-S/MC-S)
Working Temperature	-5°C~45°C
Storage Temperature	-20°C~60°
Working Relative Humidity	20%~80%
Storage Relative Humidity	20%~95%

### Notes:

Our USB2.0 camera is not compatible very well with OSX & Linux. USB3.0 cameras are recommended for Mac & Linux users and fully compatible with USB2.0 host, for more info, please refer to "Support-manual and software" on our official website.

<https://astronomy-imaging-camera.com/>

## 5. QE Graph & Read Noise

QE and Read noise are the most important parts to measure the performance of a camera.

Higher QE and Lower read noise are needed to improve the SNR of an image.

ASI120 is a very fast and sensitive USB2.0 camera. Up to 35FPS under 1280x960 full resolution!  
With a peak almost 80%, beyond ICX618 and with no FPN (Fixed pattern Noise)! Long time exposure supported up to 2000s.

Mono 120 sensor

### AR0130CS

#### SPECTRAL CHARACTERISTICS

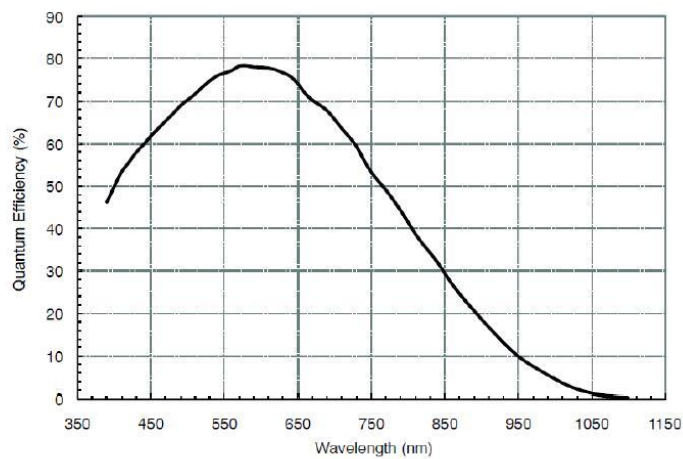
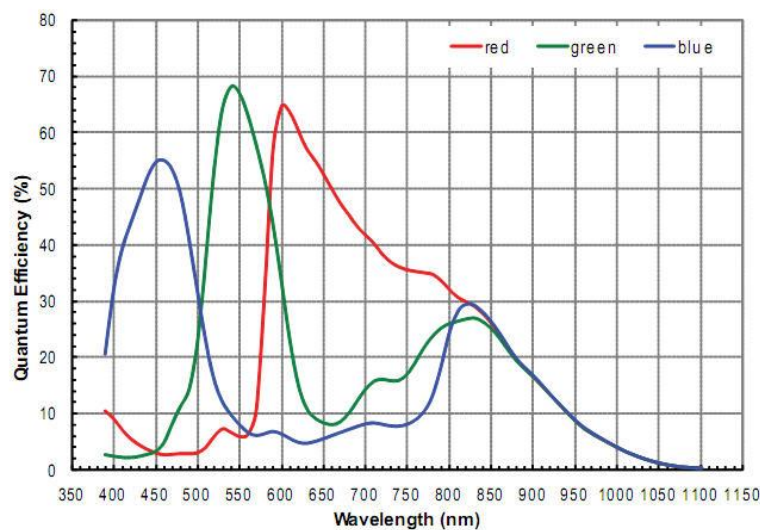

Figure 26. Quantum Efficiency – Monochrome Sensor

Color 120 sensor

Figure 24: Quantum Efficiency – Color Sensor



Read noise includes pixel diode noise, circuit noise and ADC quantization error noise, and the lower the better.

Depending on your target, you can set the gain lower for higher dynamic range ( longer exposure ) or set the gain higher for lower noise ( such as short exposure or lucky imaging).

Read noise, full well, gain and dynamic range for ASI120

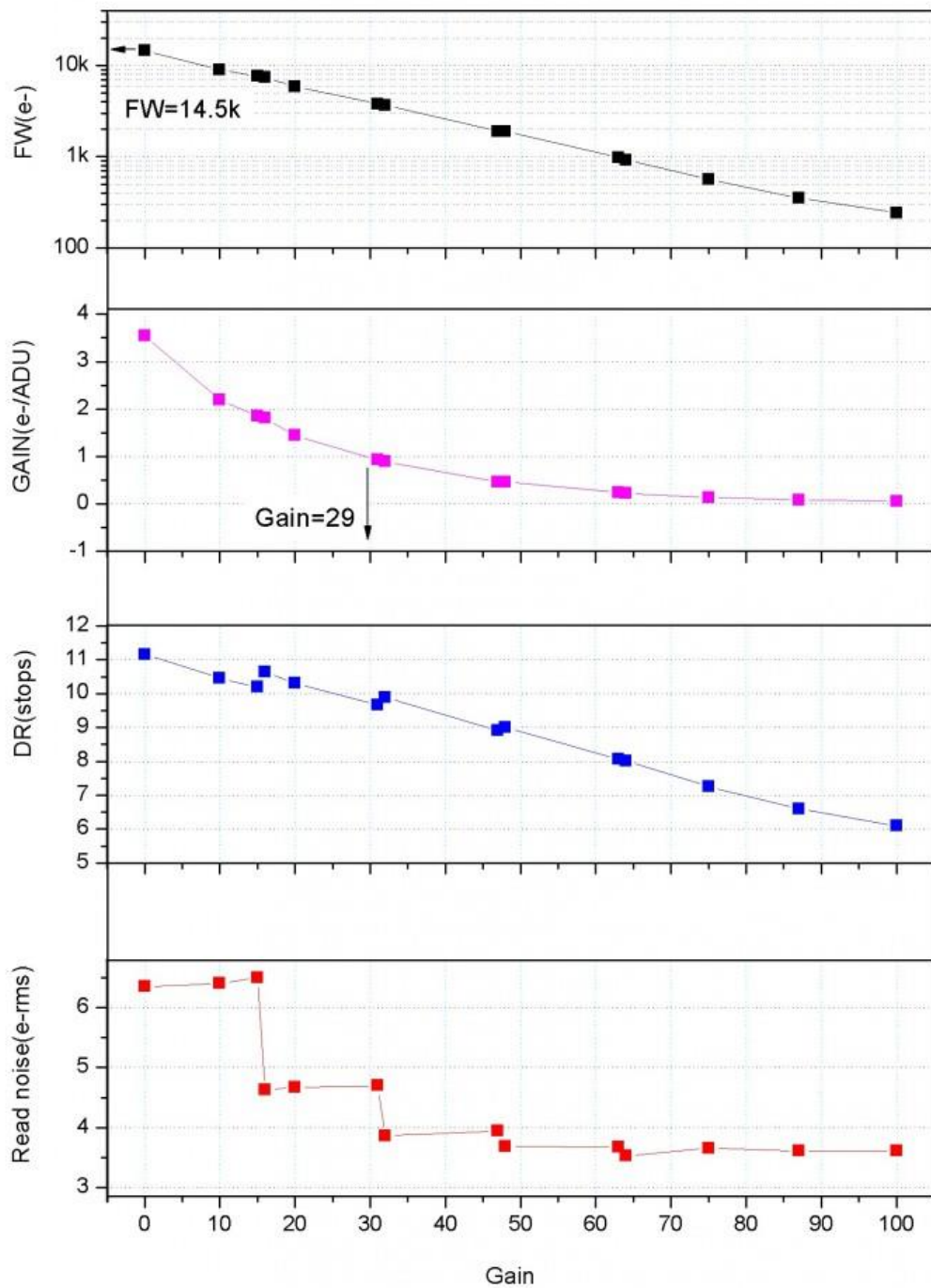



## 6. Getting to know your camera

### 6.1 External View





## 6.2 Protect Window

There is a D21 IR-CUT protect window in the ZWO ASI120MC-S camera to prevent the sensor from humidity and dust. Diameter is 21mm and 1.1mm thick.

Transmission chart of the UV IR-CUT filter:

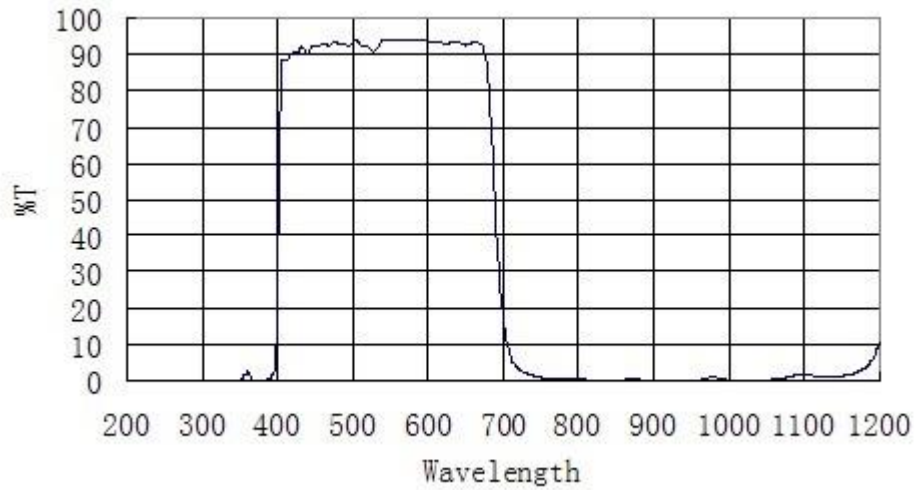

ASI120MM-S come with the D21 AR protect window.

Transmission chart of the AR filter:

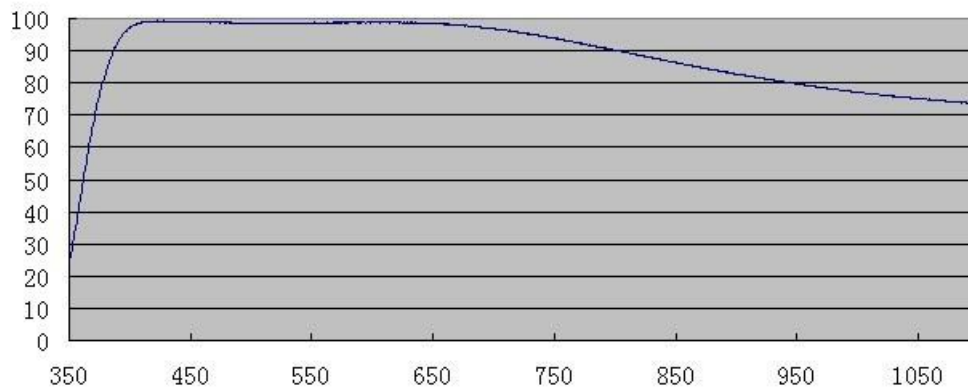

## 6.3 Analog to Digital Converter (ADC)

The ASI20 camera records in 12bit ADC. This camera also supports ROI (region of interest) shooting, and this smaller ROI has faster fps.

Here is the maximum speed of ASI120MM-S/120MC-S running at 12bit ADC .

<b>Resolution</b>	<b>120MM-S/120MC-S (12bit)</b>
1280X960	60FPS
1280X720	98FPS
1280X600	116FPS
1280X400	168FPS
960X960	74FPS
1024X768	90FPS
1024X400	160FPS
800X800	85FPS
800X640	106FPS
800X48	141FPS
640X480	133FPS
512X440	145FPS
512X400	158FPS
480X320	196FPS
320X240	254FPS

## 6.4 Binning

The ASI120 camera supports software bin2 mode.

## 7. How to use your camera

You can refer to the connecting drawing blow:

Color camera connecting drawing:

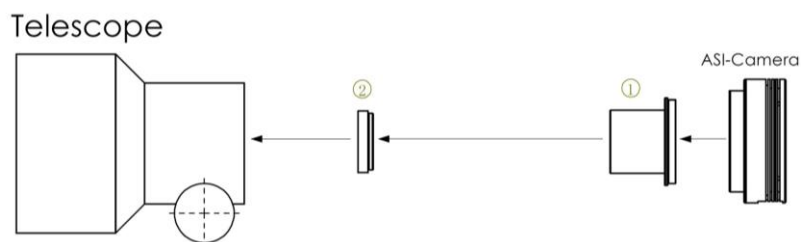

1. 1.25" T-Mount
2. 1.25" filter(optional)

Mono camera connecting drawing:

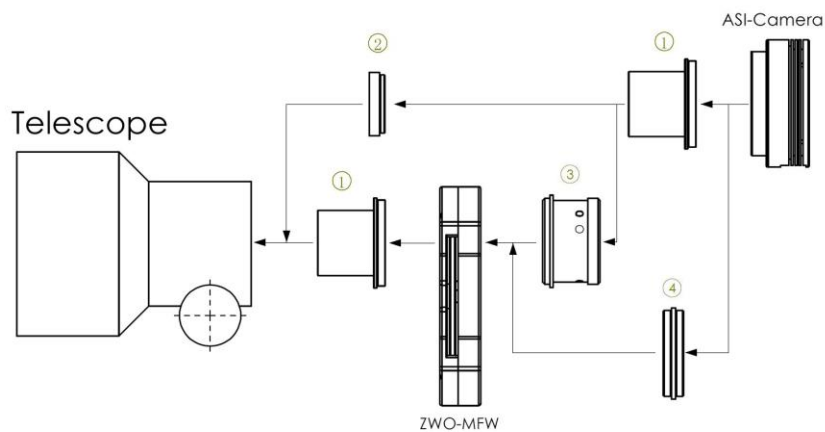

1. 1.25" T-Mount
2. 1.25" filter(optional)
3. M42-1.25" adapter
4. M42-M42 (Male screw thread)

## 8. Clean the camera and redry desiccant

The camera comes with an AR protect window, which can protect the sensor from dust and humidity. Should you need to clean the sensor, it's better to do so during the daytime. To see the dust, you just need to setup your telescope and point it to a bright place. A Barlow is required to see these dusts clear. Then attach the camera and adjust the exposure to make sure not over exposed. You can see an image like below if it's dirty.

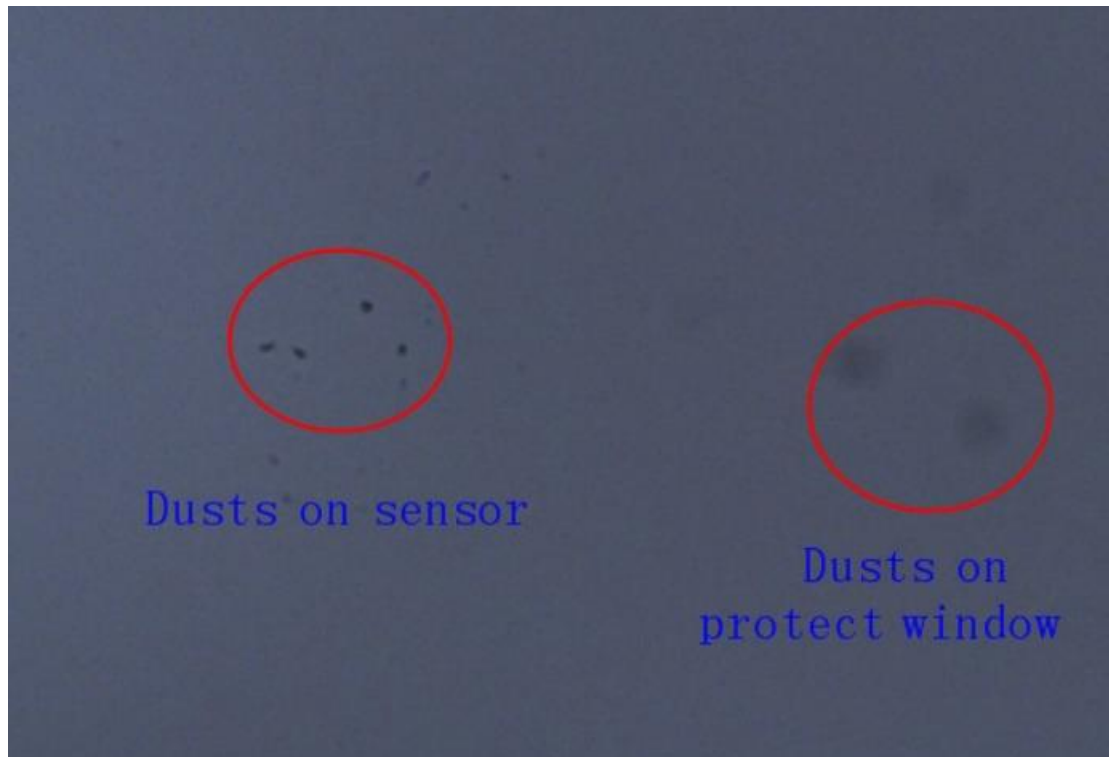

The big dim spot on the image (at right ) are the shadows of dust on the protect window.

The very small but very dark spot in the image (at left) are the shadows of the dusts on the sensor.

The suggested way to clean them is try to blow them away with a manual air pump. To clean the dust on the sensor you will need to open the camera chamber.

We have a very detailed instruction on our website:

[https://astronomy-imaging-camera.com/manuals/How\\_to\\_clean\\_ASI\\_camera\\_and\\_redry\\_the\\_desiccant.pdf](https://astronomy-imaging-camera.com/manuals/How_to_clean_ASI_camera_and_redry_the_desiccant.pdf)

## 9. Mechanical drawing

ASI120MM-S/ASI120MC-S

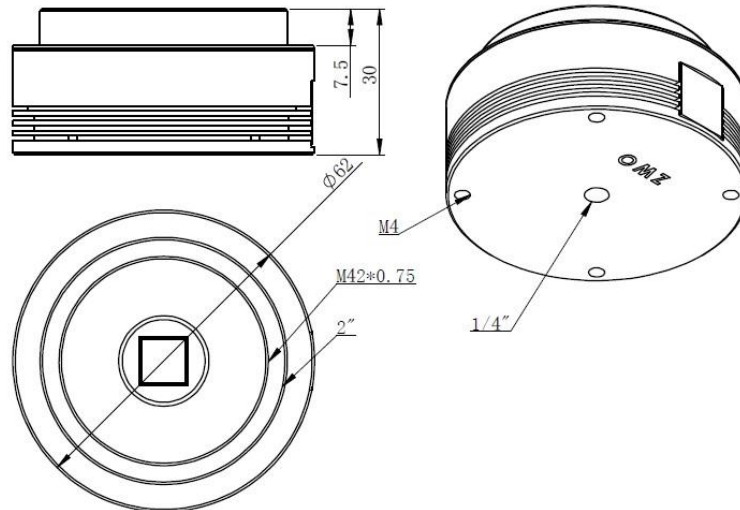

## 10. Servicing

For software upgrades please refer to “Support-manual and software” on our official website.

<https://astronomy-imaging-camera.com/>

Repairs and servicing are available by emailing [info@zwoptical.com](mailto:info@zwoptical.com)

For customers who bought the camera from your local dealer, dealer is responsible for the customer service.

## 11. Warranty

We provide 2-year warranty for our products. We offer repair service or replacement for free if the camera doesn't work within warranty period.

After the warranty period, we continue to provide repair support and service on a charged basis.

This warranty does not apply to damage that occurred as a result of abuse or misuse, or caused by a fall or any other transportation failures after purchase.

Customer must pay for shipping when shipping the camera back for repair or replacement.