

# ZWO EFW-7-2

## Product Manual



Congratulations and thank you for purchasing the ZWO EFW-25 series product. This manual will introduce the features and usage of the EFW, and guide you on its proper operation. Please read this manual carefully. If you have any questions, feel free to contact us via email at [info@zwoptical.com](mailto:info@zwoptical.com).

# Table of Contents

1. Product Overview .....	2
2. Product Specifications .....	2
3. Product Checklist .....	4
4. Product Installation Guide .....	5
5. Software and Control Methods .....	11
6. Product Dimensions .....	15
7. Product Certifications .....	15
8. After-Sales Terms .....	16
9. Contact Us .....	19

# 1. Product Overview

The EFW, short for Electronic Filter Wheel, is designed for astrophotography and works in tandem with dedicated astronomy cameras. Officially released in various configurations to accommodate different filter sizes and filter quantities, it operates via a single USB interface without requiring additional power. The official comprehensive supporting software allows you to control the EFW from Windows, Linux, or mobile systems (Android or iOS).











## 2. Product Specifications

Basic Information	Product Images	
	Product Model	EFW 7 x 2"
Key Specifications	Rotation Direction	Bidirectional
	Back Focal Length Occupancy	20mm
	Drive Method	USB 5V
	Light-Shielding Pad at Connection Point	Support
	Operating Temperature	-20~40°C
Structure	Overall Length x Width x Total Thickness (mm)	209.5 x 199 x 30

	<b>Weight (g) (Net/Gross)</b>	720g/1020g
	<b>Clear Aperture (mm)</b>	Φ51
	<b>Filter wheel Size (mm)</b>	Φ182.6
	<b>Filter Size</b>	<p>Φ2" framed filter (M48 × 0.75, filter thickness ≤7mm)</p> <p>Φ51mm frameless filter (recommended thickness 1.5mm~3.5mm)</p>
		<p>Note: Official accessories do not support frameless filters with thickness of 3.5mm~7mm. Please prepare M2 long screws (specification: M2, pitch P=0.4mm) and nut columns.</p>
	<b>Number of mounting holes</b>	7
	<b>Material</b>	Aluminum alloy
Electronic	<b>Interface</b>	USB2.0-Type-C x 1
Software	<b>ASIAIR App</b>	Support
	<b>ASISudio</b>	Support
	<b>SDK</b>	Support
	<b>ASCOM</b>	Support

### 3. Product Checklist

EFW 5x2" EFW 7x2"

 <p>EFW 2x5 Body or EFW 2x7 Body</p>	 <p>M2.5*6 Screws ( 6 pcs/bag )</p>	 <p>M2*4 Screws ( 26 pcs/bag )</p>		
	 <p>USB 2.0 Cable (0.5m x 1)</p>	 <p>USB 2.0 Cable (2m x 1)</p>		
 <p>A Bag of Filter Masks ( 10 pcs/bag )</p>	 <p>M54M-M48F</p>	 <p>M54M-M42F</p>	 <p>M54M-M48F-2</p>	 <p>3×75mm Phillips Screwdriver</p>

## 4. Product Installation Guide (using EFW 7x2" as an example)

1. Place the EFW face down (the side with the logo is the front) on the workbench. Use a Phillips screwdriver to remove the screws fixing the rear cover, then remove the rear cover. The screws are very small, it's a good idea to place them in a plastic bag or bowl after removing them.



Schematic diagram

2. EFW connected to the camera
  - a. Using a fastening connection method

If your EFW and camera use the following configuration, they connect using a direct screw-fastened mechanical interface. To secure the connection, you will need to remove the internal filter wheel from the EFW so that the mounting screws between the EFW and the camera can be tightened.

- Using EFW 5x2" or EFW 7x2" connected to 4/3", 1", small format, APS-C, or full-frame cooled cameras.
- Using EFW 7x50 connected to medium format or full-frame cooled cameras.

The specific steps for removing the filter wheel are: Loosen the 4 screws near the central screw, then lift and pull out the filter wheel. Find the matching hole position and connect the EFW to the camera (or target plane adjustment ring).

(Note: When removing the filter wheel, do not disassemble or move the central screw, as this may damage the EFW.)



Schematic diagram

**b. Use threaded connection method**

For EFWs connected to the camera via threads, directly connect the camera side to the threaded hole on the front of the EFW.



3. Reinstall the filter wheel and mount the filters. Install the filters into the wheel hole positions in your preferred order.

Pro Tip: Record which filter is installed in each numbered slot. This will be extremely helpful later when the filter wheel is closed and you need to know which filter corresponds to each position for proper astrophotography sequencing. Mixing up the filters can result in incorrect color assignment during image processing.



Schematic diagram

Filters are generally divided into framed filters (screw in type) and frameless filters (protection ring), and should be installed according to their category:

- If you are using framed filters ( $\varnothing$  1.25",  $\varnothing$  2"): Align the threaded side of the filter with the wheel hole and tighten it clockwise to secure the filter onto the wheel hole.



Schematic diagram

- If you are using frameless filters or filter modules with non-threaded protection rings ( $\varnothing$  31mm,  $\varnothing$  36mm,  $\varnothing$  51mm, 50mm square): Place the filter at the wheel hole position and secure it using the included compression ring and M2 screws.

(Note: The compression ring has directional installation—one side is glossy, and the other is matte. To avoid reflections, it is recommended to orient the glossy side toward the filter.)

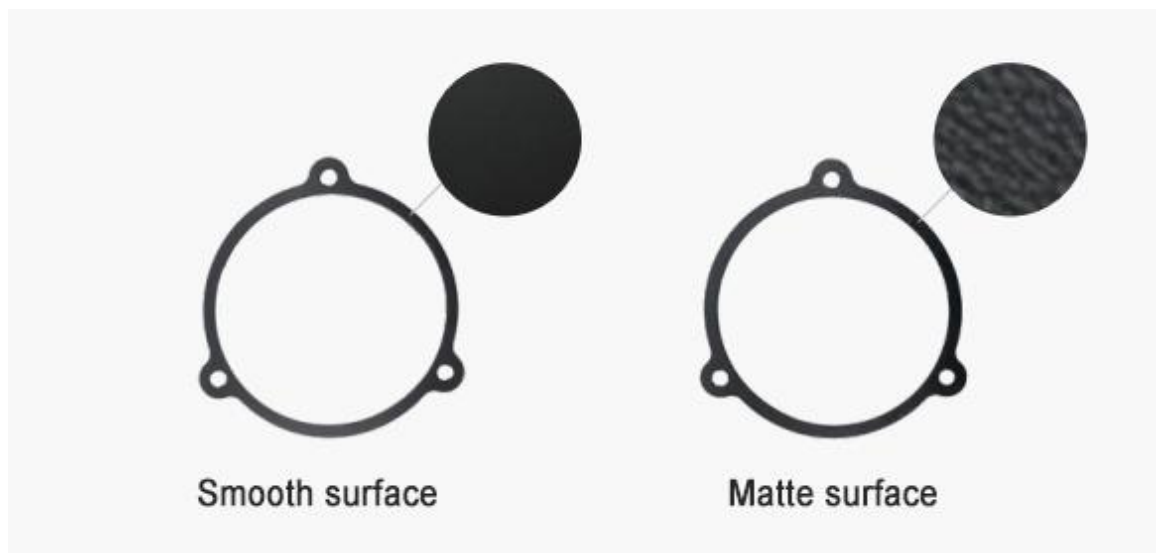

The EFW's compatibility with filters of different thicknesses is as follows:

- Threaded framed filters consist of an upper filter section and a lower threaded section. The height of the former must be less than 7mm, while the latter must

not exceed 3mm.

- When using frameless filters or filters with protection rings but without threads, the recommended filter thickness is 1.8mm~3mm.
- When using filters with protection rings, filter modules with a thickness of 1.8mm~3.5mm are supported.
- Frameless or protection ring-equipped filters thicker than 3.5mm are not supported. The officially included compression ring and M2 screw do not support filters exceeding 3.5mm. If installation is necessary, please prepare your own M2 long screws (specification: M2, pitch P=0.4mm) and nut columns to securely fasten the filter.

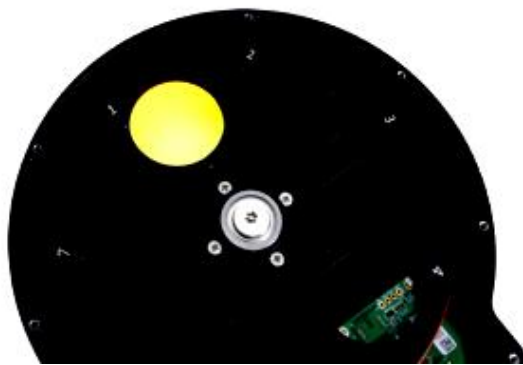

4. Reattach the top cover to the EFW and tighten the screws.



This is a sample diagram.

5. Finally, connect the assembled camera end to the telescope's adapter ring.



(Note: For the optimal back-focus solution regarding camera-telescope connection, please refer to the official platform website.)



## 5. Software and Control Methods

The EFW can be understood as a USB peripheral similar to a mouse or keyboard. The installation process is straightforward—you can either use the official software directly without drivers or install the ASCOM driver to use third-party software.

### 5.1 Controlling with Official Software (Supports Mobile and PC Platforms)

Depending on the EFW's cable connection method, use the corresponding official software to control it.

- If the EFW is connected to a computer port, it is recommended to use ASISudio (supports Windows, macOS, Linux).
- If the EFW is connected to a ZWO ASIAIR astronomy control box, it is recommended to use the accompanying ASIAIR APP (Android, iOS) to control the EFW.

#### 5.1.1 Controlling the EFW with ASISudio

Please visit the ZWO official website to download and install the ASISudio software.

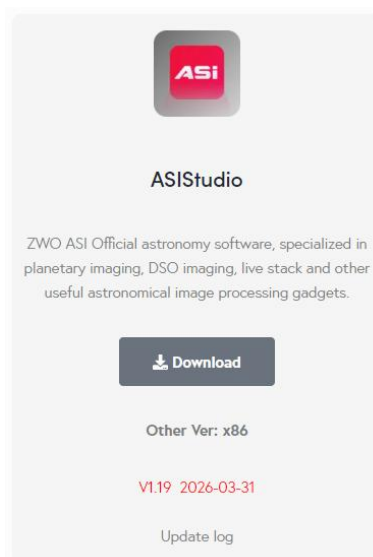

Launch ASIStudio, select an imaging program, here, deep-sky photography  
ASIIImg is used as an example (planetary imaging ASICAP setup is similar).

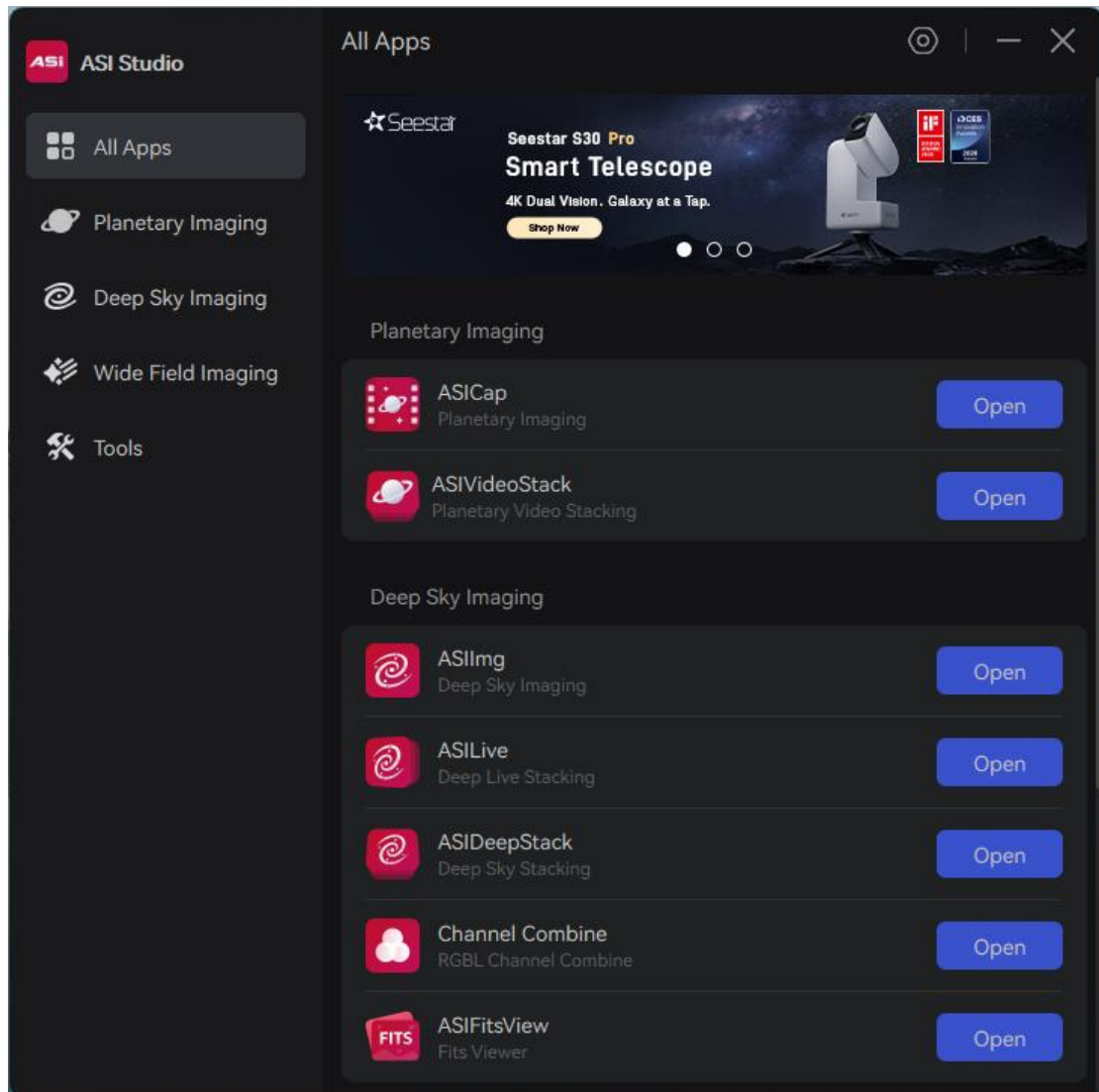

In the newly launched ASIIImg program interface, select 'EFW Setting' to open the EFW configuration panel.



From the dropdown menu, select the EFW you are connected to, then click the arrow button on the right to establish the connection.

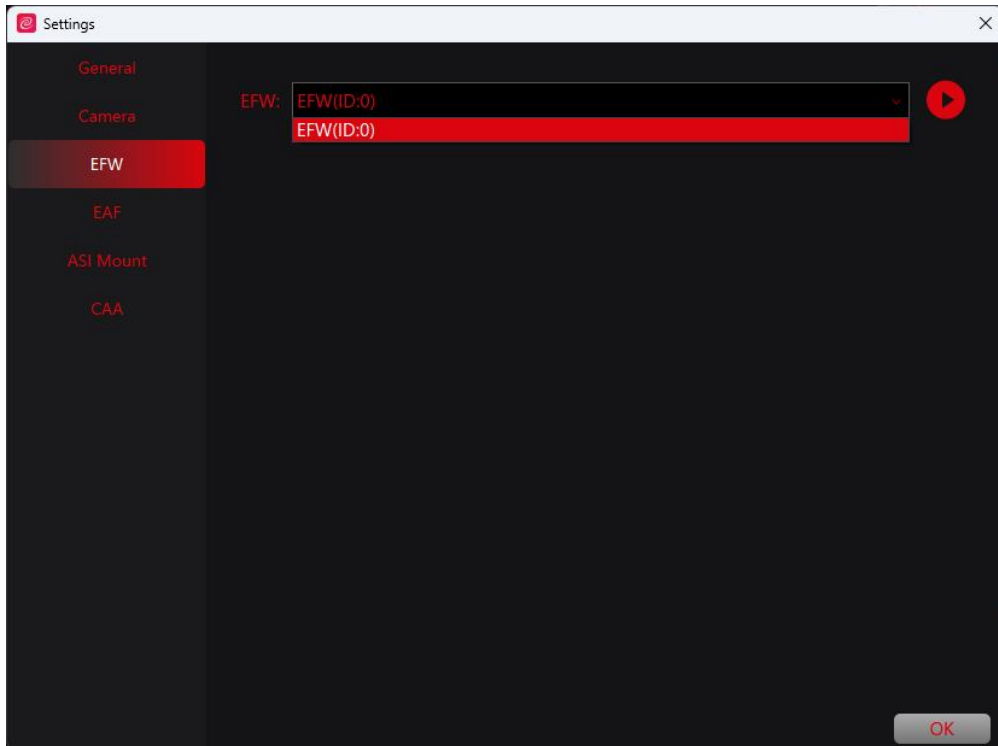

After the EFW is correctly connected, a list corresponding to the number of holes will appear. By default, each hole is named with a number. Clicking on a list item allows you to customize the name of each filter hole.

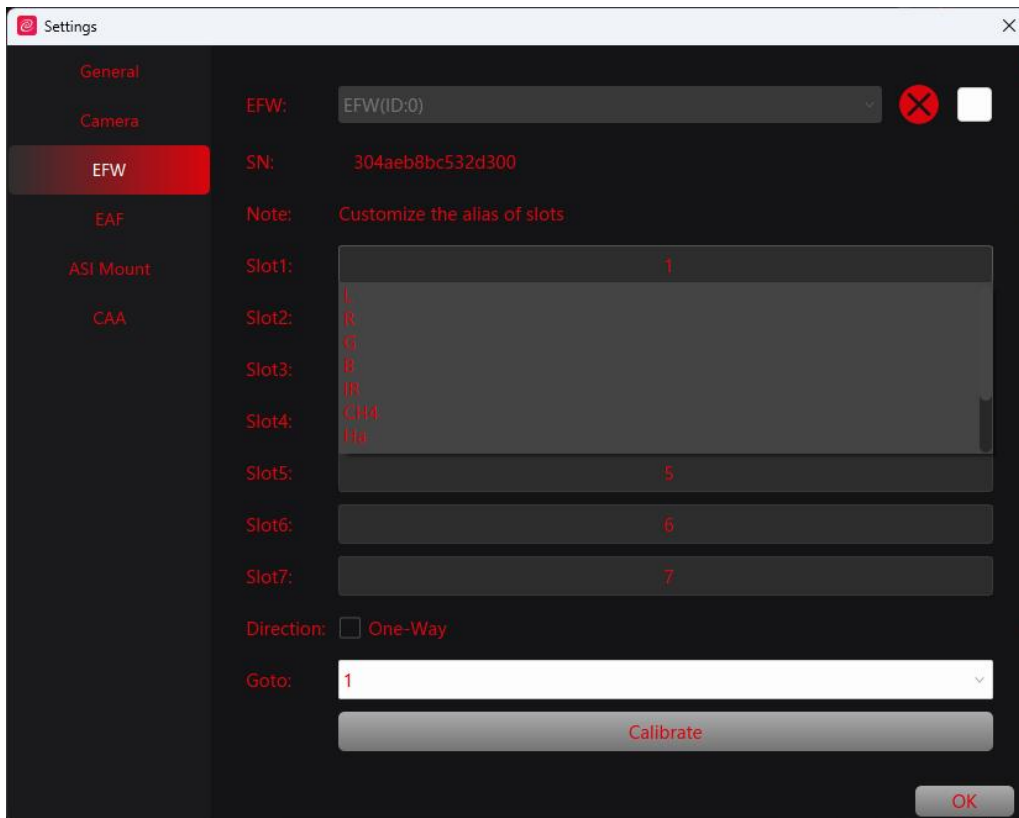

After customizing the names of all holes, click 'OK' to complete the setup.

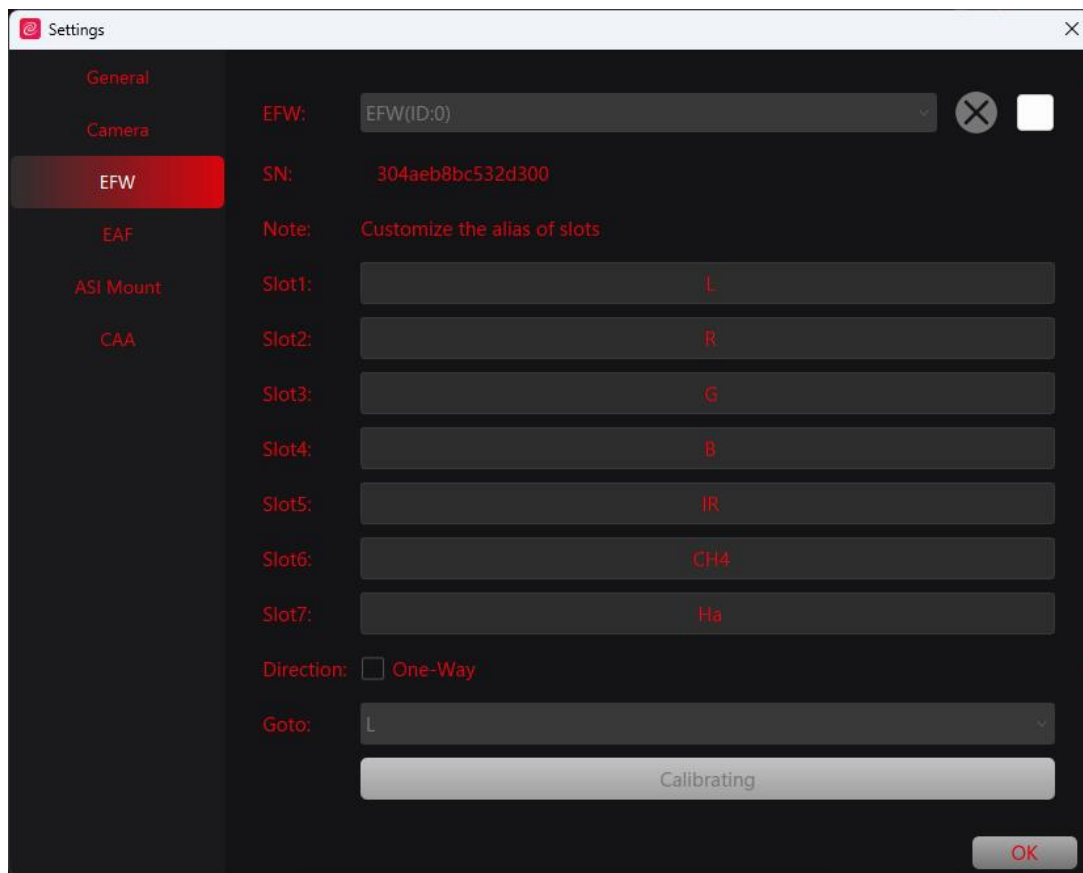

You can temporarily set the filter for live view on the main interface, or preset suitable filters in scheduled imaging for capture.

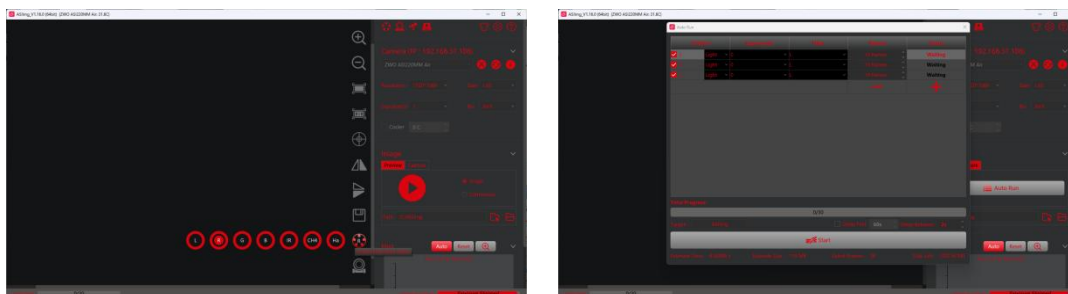

## 6. Product Dimensions

ZWO EFW-7x2-25

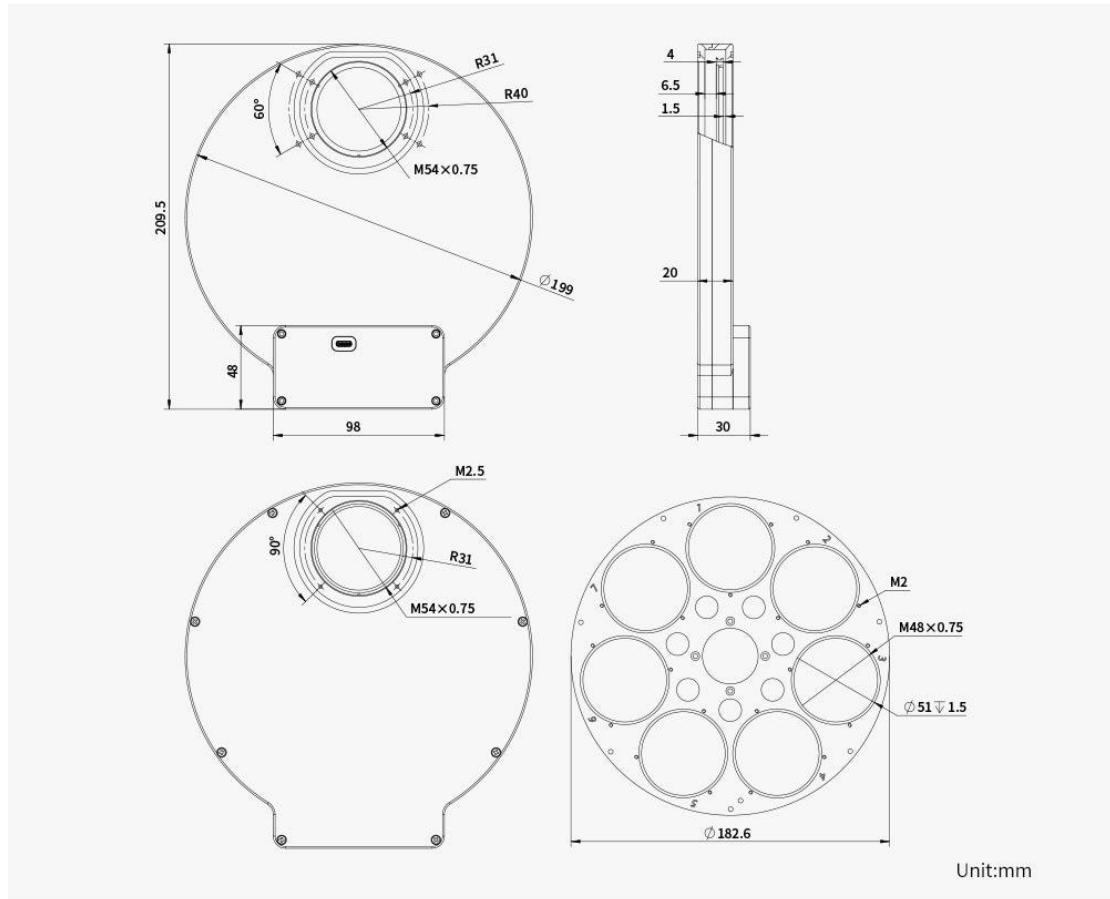

## 7. Product Certifications

EFW series products have passed the following certifications:



## 8. After-Sales Terms

### 8.1 After-sales Service

For software upgrades, visit the official website to download updates directly: “Homepage → Software Download”.

<https://www.zwoastro.com/>

For repairs and other services, please contact us:

Domestic users can follow the ZWO WeChat Official Account and click “Contact Customer Service”.

Overseas users can visit the after-sales service page on ZWO's international website <https://support.zwoastro.com/> , submit a service ticket.

Email address: [info@zwoptical.com](mailto:info@zwoptical.com)

Phone: 0512-65923102

1. For products returned for normal repair or replacement during the warranty period, users shall bear the return shipping costs. When returning products, users should note the actual cause of damage and provide valid proof such as photographs or video evidence.

For products requiring replacement as confirmed in writing by ZWO, users must return the fully packaged product with all accessories and manuals to the ZWO-specified address. By returning products, users agree to pay any repair fees outside the warranty coverage. ZWO will return the product after payment is received.

2. For products requiring return for after-sales service, ZWO will provide a corresponding RMA code for reference. ZWO does not accept any products returned without prior written confirmation from ZWO and without an RMA number.

3. If the product was purchased through a ZWO Agent, users may contact the Agent directly to obtain relevant after-sales service.

## 8.2 Warranty Policy

1. ZWO provides a 2-year free warranty (1-year warranty for batteries) for products purchased directly from us, effective from the date of user receipt.

2. If users encounter Dead on Arrival (DOA) situations as described below and contact ZWO within the specified period, providing purchase invoices and relevant proof, ZWO will arrange door-to-door pickup and provide product replacement (or partial replacement), repair, or return (or partial return) services as appropriate:

1) Product Quality Issues: If a user discovers a quality issue with the product within 30 days of receipt and contacts ZWO, and if ZWO Customer Service Center testing confirms that the product has inherent quality defects or flaws, ZWO will provide a free replacement service.

2) Product Shipping Issues: If, upon receiving the product, the user finds obvious signs of water damage, severe crushing, or deformation on the outer packaging, and provides relevant pictures of the outer packaging and proof of receipt to ZWO within 3 days of receipt, and if ZWO Customer Service Center verification confirms that the product was shipped directly by ZWO to the user or an Agent, then ZWO will provide relevant return or replacement services. If the product was sold or shipped directly to the user by a ZWO Agent, then the ZWO Agent will be responsible for providing the relevant return or replacement service.

3. The following situations fall outside the warranty coverage, but ZWO can provide repair services to users:

- 1) The product exceeds the warranty period;
- 2) Liquid ingress or corrosion due to moisture exposure;
- 3) Damage caused by external force (e.g., surface scratches, housing deformation, Type-C port breakage);
- 4) Unauthorized disassembly, third-party repairs, modification/refurbishment, or firmware flashing (incorrect firmware installation) without ZWO's written explicit

authorization;

5) Alteration of the product system or loss/alteration of warranty labels;

6) Product quality issues resulting from installation not in accordance with requirements or instructions;

7) Physical damage or malfunction caused by irresistible external forces (e.g., floods, fires, earthquakes, lightning strikes, severe vibration, or compression).

8) Damage caused by improper operation during imaging or use;

9) Absence of valid purchase invoice and warranty documentation;

10) The customer purchased a second-hand product.

If supplied accessories or other components exhibit quality issues, this does not constitute grounds for returning or exchanging the main unit. Customers may separately request replacement of new accessories.

Note: Any modifications to this manual will be implemented without prior notice.

## 9. Contact Us



Scan to visit our  
website

Official website: <https://zwoastro.com>

Facebook: <https://www.facebook.com/zwoastro/>

Instagram: <https://www.instagram.com/zwoastro/>

Twitter: <https://twitter.com/zwoastro>

Tel: +86 0512 65923102