

# ZWO-AM7

## User Manual



# Table of Contents

Preface .....	2
Tips .....	3
Package Lists .....	4
1. Product Introduction .....	5
2. Performance Parameters .....	6
3. How to Use .....	7
3.1 Introduction to the AM7 .....	7
3.2 Introduction to the Hand Controller .....	9
3.3 Mounting the AM7 .....	10
3.3.1 Mount Installation .....	10
3.3.2 Mount Hand Controller .....	11
3.3.3 Bluetooth .....	12
3.3.4 Optional Accessory Installation .....	12
3.4 How to use AM7 .....	15
3.4.1 How to adjust the latitude from the first gear to the second gear .....	15
3.4.2 How to adjust the azimuth scale .....	17
3.4.3 How to switch the equatorial /alt-azimuth mode .....	18
3.4.4 How to control the AM7 on PC .....	19
3.4.5 How to control the AM7 via ASI AIR .....	23
3.4.6 How to control the AM7 via Bluetooth/Wi-Fi .....	24
3.4.7 How to upgrade the Firmware of AM7 .....	27
4. Structural Dimensions .....	32
5. After Sales .....	34
6. Warranty .....	35
7. FCC .....	36
8. ISED .....	37

# Preface

Thank you for purchasing the ZWO Harmonic Equatorial Mount, the ASI Mount 7 (here after referred to as the AM7 Equatorial Mount). ZWO, through years of research and tailored specifically to the demands of astrophotography, has engineered a harmonic drive with ultra-low periodic error and a stable transmission of high torque output. Each AM7 Equatorial Mount includes in the box a comprehensive 360° Periodic Error (PE) test report to ensure performance. Utilizing belt-driven technology, it achieves an overall reduction ratio of 300:1 for precise control. The AM7 equatorial mount achieves a unity of lightweight design and stability through the application of integrated manufacturing processes and the incorporation of modern industrial design principles. While emphasizing portability, the product places even greater focus on operational stability and the harmony of overall performance. It is a meticulously crafted harmonic German-style equatorial mount. Its load-bearing capacity can meet the requirements of some portable and remote observatory professional photography equipment for hanging capacity. The AM7 Equatorial Mount has been developed with full intellectual property rights in both hardware and software and is perfectly compatible with ASIAIR. Furthermore, it supports platforms such as ASCOM and INDI.

The mount features quick response, precise tracking, convenient operation, and wide compatibility, meeting the demands of both visual astronomy enthusiasts and astrophotographers. It will enrich the celestial exploration journey for all astronomy lovers.

The purpose of this manual is to introduce the methods of using the equatorial mount through textual explanations and illustrations and to alert users of potential improper operations or hazardous situations. Please ensure that you thoroughly read and understand this manual before operating the equatorial mount and that you operate the mount strictly according to the instructions provided. Any damage to the equipment or personal injury resulting from improper operation shall be the responsibility of the user.

# Tips

This manual can guide users to use the equatorial mount safely and efficiently. Before using the equatorial mount, please make sure to carefully read the following warm tips and strictly adhere to the guidance of this manual during actual use.

- 1) When using this equatorial mount, do not observe the sun directly with the naked eye through the telescope or finder scope, as this can cause permanent and irreversible damage to the observer's eyes. When observing the sun, please be sure to equip a special solar filter;
- 2) Please choose the appropriate tripod and balance weight carefully according to the size and weight of the primary mirror. The harmonic equatorial mount without added weights will cause the telescope's center of gravity to deviate from the tripod. Please test the center of gravity changes of the telescope when turning to various directions in advance to avoid the equatorial mount tipping over, which can cause equipment damage or personal injury.

The equatorial mount can be used without a counterweight if the total telescope weight is less than 20kg. When the total telescope weight reaches or exceeds 20kg, a counterweight must be installed, and the total telescope weight must not exceed 30kg. (Maximum output torque: 40 N·m);

- 3) If the equatorial mount is powered on not at the zero position, please return to the zero position first, then proceed with other operations. After using the equatorial mount, please return it to the zero position first, then disconnect the power, otherwise, it may cause the next start-up to be inaccurate or use the GOTO function to cause equipment damage or personal injury;
- 4) Please avoid children touching the equatorial mount alone to prevent the equatorial mount from tipping over or causing personal injury. In addition, the small parts included in this equatorial mount may also cause choking or other injuries to children;
- 5) Do not place the equatorial mount in environments with high humidity or high salinity, which will cause corrosion to the parts of the equatorial mount, which may lead to the equatorial mount running poorly or reduce the accuracy of the equatorial mount, and even cause short circuits and permanent damage;
- 6) Do not use corrosive solutions to clean the equatorial mount to avoid corroding the surface oxide layer, damaging the equatorial mount; and avoid exposing the equatorial mount to the sun for a long time to prevent discoloration of the exterior oxide layer;
- 7) Do not attempt to disassemble the equatorial mount alone, this may cause damage to the equatorial mount, reduce the accuracy of the equatorial mount, and even cause personal injury to the user;
- 8) The equatorial mount is a precision instrument, please handle it with care to avoid knocking and damaging the equatorial mount, reducing accuracy;
- 9) The operating temperature range for the equatorial mount is -20°C to 40°C. Do not use it outside this temperature range to prevent the equipment from not functioning properly, resulting in equipment damage. If not used for a long time, please store it properly in the packaging box.

# Package Lists

①

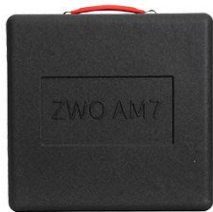

②



③



④

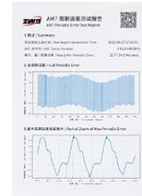

⑤



⑥



⑦



⑧



⑨



- ① Foam packaging box x1
- ② Equatorial mount unit x1
- ③ 2-meter USB 2.0 cable (Type-B to Type-A) x1
- ④ AM7 periodic error test report x1
- ⑤ Quick guide x1
- ⑥ Control hand pad x1
- ⑦ 2-meter hand pad connection cable x1
- ⑧ 1-meter USB 2.0 cable (Type-C to Type-A) x1
- ⑨ M6 hex key x1

# 1. Product Introduction

AM7 is the first equatorial mount in ZWO's ASI Mount series. It has been greatly improved compared to its original edition, offering larger load capacity, higher precision, better low-temperature tolerance, and better cable management, greatly enhancing the user experience. This mount combines portability, accuracy, intelligence, and high performance, catering to the diverse needs of astronomy enthusiasts in the field.

## **Key features include:**

- 1) High precision: Equipped with a specialized astronomical harmonic reducer, it achieves high-precision control with a periodic error consistently within  $\pm 10$  arcseconds. This ensures stable transmission of large torque output, and each machine's PE error curve is tested to guarantee performance.
- 2) High load capacity: The main body weighs 6.75kg and can carry up to 20kg, which can be increased to 30kg with added counterweights.
- 3) Proprietary control system: A completely proprietary software and hardware control system maintained and upgraded by a professional team to ensure stability.
- 4) Dual-mode: Offers both equatorial and alt-azimuth modes to cater to both imaging and visual observation needs.
- 5) No regional limitations: Designed with a 0-90-degree pitch angle, it can be used at the equator and polar regions.
- 6) Hand controller/APP control: Features like best targets of the night recommendations, target GOTO, and star chart display on the APP. OTA (Over-the-Air) online firmware upgrades for the equatorial mount and hand controller can be completed on a smartphone without the need for a computer connection.
- 7) Cable management: Supports cable management with an integrated DC output and Type-C port on the dovetail board, effectively preventing cable entanglement.
- 8) Bluetooth functionality: The APP has added Bluetooth connectivity for controlling the equatorial mount, significantly improving the control experience. Support the on and off of Bluetooth function.

## **Additional Advantages:**

- 1) Fully sealed transmission components: The harmonic drive is designed with a fully sealed structure, ensuring that the harmonic reducer does not rust over time and that its performance remains consistent.
- 2) One-click mechanical zeroing: The design features mechanical zeroing, supporting a one-click return to zero position from any position.
- 3) Power-off brake device: In the event of a power failure, the RA axis has brake protection to prevent the primary mirror from falling and causing damage to the equipment or personal injury.
- 4) APP/PC software to meet different needs: Mobile devices can install the "SkyAtlas" or "ASIAIR" APP to control the AM7, while computers support control by ASISudio, ASCOM, and INDI.

## 2. Performance Parameters

Items	Description
<b>Mount type</b>	Strain Wave Gear Mount
<b>Mount mode</b>	Equatorial/Alt-Azimuth
<b>Drive</b>	Strain Wave Gear + synchronous belt (300:1 reduction ratio)
<b>Periodic error</b>	<±10"
<b>PE duration</b>	288 s
<b>Drive (R.A.)</b>	Stepper motor + synchronous belt + 20type 100 reduction ratio strain wave gear + brake
<b>Drive (DEC)</b>	Stepper motor + synchronous belt + 17 type 100 reduction ratio strain wave gear
<b>Payload</b>	20kg (without counterweight) /30kg (with counterweight)
<b>Mount weight</b>	6.75kg
<b>Latitude adjustment range</b>	0°-90°
<b>Azimuth adjustment range</b>	±7.5°
<b>Dovetail saddle</b>	Losmandy & Vixen
<b>Interface thread for counterweight bar</b>	M16×2 coarse teeth
<b>Resolution</b>	0.17"
<b>Max slew speed</b>	6°/S
<b>Slew speed</b>	0.5×, 1×, 2×, 4×, 8×, 20×, 60×, 720×, 1440×
<b>Power port</b>	DC D5.5×2.1mm, center positive (12V, no less than 5A)
<b>Power consumption</b>	Standby: 0.75A/0.68A, Tracking: 0.95A, GOTO: 2.1A
<b>Auto Guide port</b>	ST4
<b>Communication</b>	USB/Wi-Fi/Bluetooth
<b>Zero position</b>	Mechanical
<b>Operating</b>	-20°C to +40°C
<b>Power-off brake</b>	RA axis
<b>Park</b>	Support
<b>Cable Management</b>	Support

# 3. How to Use

## 3.1 Introduction to the AM7



① **Finder Scope Slot Mounting Hole:** Can be used to mount the finder scope slot, then install the ASI AIR, laser pointer.

② **Power Switch:** Connects or disconnects power to the AM7.

③ **Latitude Gear Adjustment Screw:** A pair of screws are on both sides of the mount. Loosen them with the M6 Allen key, then adjust your desired latitude gear. Don't forget to tighten them after adjustment.

④ **Latitude Lock Knobs:** Loosen the knob to adjust the latitude. Don't forget to tighten it after adjustment.

⑤ **Latitude Fine Adjustment Knob:** Rotate it clockwise to get the mount up in latitude and counterclockwise to get it down in latitude.

⑥ **Azimuth Fine Adjustment Knobs:** Rotate the knobs in opposite directions to each other to adjust the azimuth base. It is best to keep the knobs slightly done up to prevent wobble.



⑦ **Counterweight Bar Screw Hole:** By loosening the nut, you can mount the counterweight bar and counterweights, M16×2 coarse thread.

- ⑧ **Auto Guide:** ST-4 compatible autoguiding port.
- ⑨ **USB 2.0 Interface:** Equipped with a USB-B 2.0 port, which can be used to connect devices that support a USB connection. This interface allows for control of the AM7 and firmware upgrades.
- ⑩ **BT Button/Bluetooth Indicator Light:** The BT button is used during the Bluetooth pairing process to confirm and lock the connection to the correct AM7, preventing accidental connection to other devices.

The indicator light displays a steady blue when the AM7 is powered on and operational. Once the APP successfully connects to the AM7 via Bluetooth, the indicator light turns off. (Note: Bluetooth connections can only be made through the AM7 APP interface).

- ⑪ **HC:** Hand Controller Interface – used to connect the hand controller device.
- ⑫ **DC 12V5A:** Power Input Interface.12V DC, minimum 5A . The actual current requirement shall be calculated based on the total power consumption of all connected devices.The DC connector size of D5.5×2.1mm with a center-positive, outer-negative polarity (meaning the inner connector is positive (+) and the outer shield is negative (-)). A low voltage alarm is activated, and the AM7's buzzer will sound if the voltage falls below 10.8V, indicating that the power is insufficient.
- ⑬ **Status:** It is an operation mode indicator light. Red light for the equatorial mode, green light for the alt-azimuth mode. It will flash red and green when the time and location information is not synchronized to the AM7. Once synchronized, it will keep the light on in the mode's color accordingly.

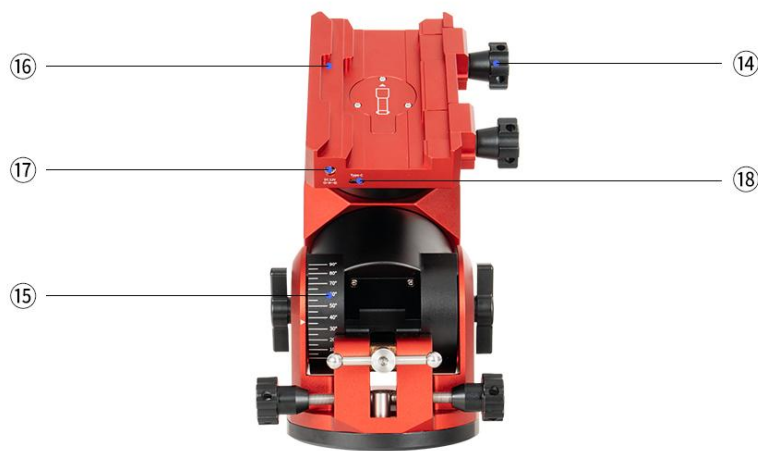

- ⑭ **Dovetail Saddle Locking Knobs:** Compatible with Vixen/Losmandy style dovetail bars.
- ⑮ **Latitude Scale:** Indicates the current latitude of the AM7 from 0° to 90°.
- ⑯ **Dovetail Saddle Plate:** Designed for mounting and securing the telescope's dovetail plate, Compatible with Vixen/Losmandy style dovetail bars.
- ⑰ **DC Power Port:** DC12V,The port can function as either an input to power the mount (with the same requirements as port ⑫) or as an output to power external devices like the ASI AIR. When two DC ports are used in parallel, only one can be set as the input source at a time; the other will automatically switch to output mode.
- ⑱ **Type-C Port:** Can be used to control AM7, update firmware, etc., and connect to devices with a Type-C interface (such as ASI AIR) or a computer (with the same functionality as the previous USB2.0).

## 3.2 Introduction to the Hand Controller



① **Indicator Light:** Indicates the current speed mode of AM7. When the red light is on, the mount is in high-speed mode (20-1440 times sidereal rate), while a red light that is off indicates low-speed mode (1, 2, 4, 8 times sidereal rate).

② **Joystick:** Can be used to control both axes to move accordingly and vertically press down on the joystick to switch between high and low speed modes.

③ **T Button:** Click to turn tracking on or off. When the tracking is on, the T button will turn the red light on, and the status indicator of the AM7 will flash red (green) in the equatorial (alt-azimuth) mode.

④ **Function Cancellation:** Press briefly to cancel functions, such as stopping the GOTO process on the AM7 by pressing the cancel button.

**AM7 Zeroing:** Press and hold for 3 seconds to reset the AM7 to its home position.

**Mode Switching:** While the AM7 is turned off, press and hold the cancel button without releasing it, until the indicator light changes color after the AM7 turns on, then you can release the button. Mode switch on the AM7 succeeds now.

### **How to determine the current mode of the equatorial mount?**

After turning on the equatorial mount, if the indicator light is red within the first 5 seconds, it indicates equatorial mount mode; if it is green, it indicates alt-azimuth mount mode.

### **Note:**

**How to get the Wi-Fi information for the hand controller:** Each hand controller has a silver nameplate on the back with the Wi-Fi information for that controller, including the SSID and password for the hand controller's Wi-Fi.

**If you forget the hand controller's Wi-Fi password: (The hand controller has a built-in Wi-Fi module for wireless control and firmware upgrades.)**

If you forget the hand controller's Wi-Fi password, you can reset it by pressing and holding both the tracking and cancel buttons on the AM7 while it is turned off. Continue holding these buttons until 5 seconds after the AM7 powers up and turns on, at which point the hand controller's indicator light will flash, indicating that you can release the buttons. This resets the Wi-Fi password to the default password: 12345678.

## 3.3 Mounting the AM7

### 3.3.1 Mount Installation

\*Tripod model: ZWO carbon fiber TC40  
(optional)

**Unfold the tripod**



**Install the silver mounting plate:**

Fix the silver mounting plate onto the base of the AM7 with three M6 screws.



**Install the AM7 onto the tripod:**

Place the AM7 with the silver mounting plate installed onto the tripod, insert the multi-function support rod as shown in figure below (see figure 1), rotate the knob on the multi-function support rod clockwise and tighten it, then fit the tripod spreader and rotate its knob clockwise to lock it in place.



### 3.3.2 Mount Hand Controller

Hand Controller Installation:

Connect the hand controller to the AM7 using the supplied hand controller cable, and plug it into the [HC] hand control port on the AM7. The hand controller has a built-in Wi-Fi module, allowing wireless devices with WLAN capability to connect to the hand controller's W i-Fi for wireless control of the AM7.



### 3.3.3 Bluetooth

The AM7 has added Bluetooth functionality. If you forget to bring the hand controller when you go out, the APP can control the AM7 via Bluetooth connection.

- **BT Connect:**

Open the "SkyAtlas" app, select [Mount Settings], and in [Select Device Control Method], choose [Bluetooth] for a Bluetooth connection. Follow the prompts to proceed. After a successful connection, the blue BT indicator light on the AM7 unit will turn off.



- **BT Reset:**

To perform a Bluetooth reset, press and hold the BT button for over 3 seconds while Bluetooth is on. Release the button when the indicator light starts blinking.

- **BT Switch:**

To check the Bluetooth status when the device is powered on, briefly press the BT button. If the blue indicator flashes once, it indicates that Bluetooth is currently enabled. If no blue light appears, Bluetooth is disabled.

### 3.3.4 Optional Accessory Installation

#### A. Pier extension connection to Equatorial Mount (Optional)

a. Assemble the mounting plate onto the equatorial mount

Remove the three M6 screws used to fix the mounting plate on the tripod, and then lock the mounting plate tight onto the equatorial mount.

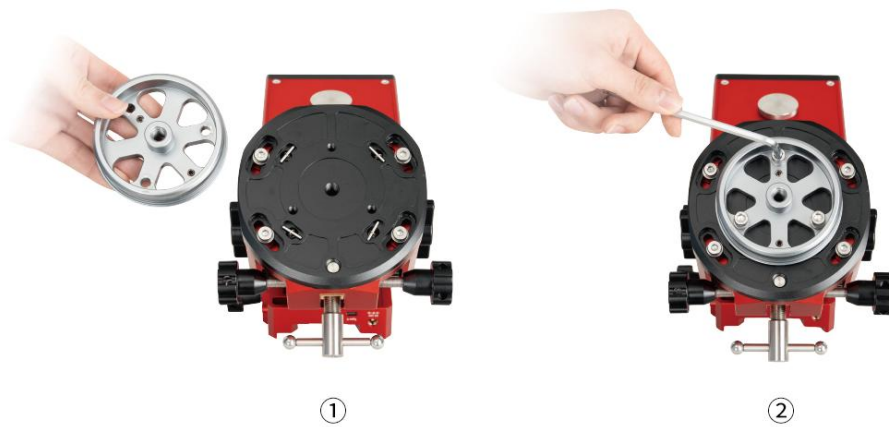

b. Assembly of the pier extension onto the Tripod:

Mount the pier extension body onto the tripod and tighten the knobs on the tripod to secure it in place.



Insert the multi-function support rod as shown in figure below (see figure 1), rotate the knob on the multi-function support rod clockwise and tighten it, then fit the tripod spreader and rotate its knob clockwise to lock it in place.



- c. Mount the AM7 body onto the pier extension and tighten the knobs on the pier extension.
- d. Pier extension installation Completed.



## B. Counterweight Rod/Counterweights Installation (Optional)

### How to Determine Whether to Install Counterweights

If the total weight of the telescope and associated equipment is less than 20KG, the equatorial mount can be used without installing counterweights; however, when the total weight exceeds 20KG, the equatorial mount will need to use counterweights, and the total weight should not exceed 30KG (the center of gravity for the load including the counterweights should be within a 20cm lever arm).

To ensure the stability of the entire system, when the total weight of the telescope and associated equipment reaches 20KG, it is advisable to use counterweights. The counterweight rod has a threaded interface with a coarse thread size of M16×2.

### Counterweight Rod/Counterweights Installation Steps:

- a. Locate the counterweight mounting screw hole at the bottom of the AM7 unit.
- b. Unscrew the counterweight rod thread hole protective nut counterclockwise until it's completely unscrewed and removed, exposing the screw hole.
- c. Align the counterweight rod with the screw hole and rotate it clockwise to tighten it, then install the counterweights.
- d. Install the nut removed in step 2 onto the end of the counterweight rod.



## 3.4 How to use AM7

### 3.4.1 How to adjust the latitude from the first gear to the second gear

#### Introduction to the latitude gear:

The AM7 equatorial mount's latitude adjustment is divided into two gear positions, with a range of 0 to 60 degrees for the first gear and 30 to 90 degrees for the second gear. When the equatorial mount is in the first gear, the maximum adjustment angle can only reach 60 degrees; to achieve a larger angle, you need to use a hex wrench to loosen the "latitude gear position adjustment screws" on both sides of the main body. Then, you can pivot the mount and adjust the "altitude fine-tuning knob" to the second gear (at the 90-degree mark on the altitude scale). After the adjustment, tighten the screws on both sides to achieve an adjustment range of 30 to 90 degrees (make sure the latitude tensioner is in a relaxed state when adjusting the altitude). It is recommended to adjust the equatorial mount's gear position when it is not carrying any load.



Latitude scale 0°



Latitude scale 90°

**Adjust the latitude from the first gear to the second gear (Adjust the latitude angle from 0° to 90°), as follow:**

Loosen the "altitude tensioner" on both sides. Rotate the "altitude fine-tuning knob" clockwise until the hexagonal screw (the "altitude gear position adjustment screw") is fully visible from the hole (approximately at the first gear, 45° position).



①



②

Using an Allen wrench, turn the hex screws on both sides counterclockwise to fully loosen them. (Note: When tightening or loosening the gear screw, do not place your hand at the middle Angle between the base and the harmonic module to avoid pinching your fingers.)



③



④

Manipulate the equatorial mount to slide and adjust the "altitude fine-tuning knob," allowing the hex screw to slide to the bottom end of the hole's slide rail, with the scale screw indicating at the 90° position. At the same time, expose the hex screw and retighten the hex screws on both sides (Note: After adjusting the gear position, be sure to tighten the gear screws firmly, otherwise the equipment may become loose and the gear adjustment function can be easily damaged).



⑤



⑥

At this point, the equatorial mount is in the second gear position. In this state, the equatorial mount can adjust the tilt angle within a range of 30° to 90°. After the adjustment is completed, tighten the altitude tensioner.



⑦



⑧

To adjust from the second gear to the first gear, simply reverse the steps outlined above.

### 3.4.2 How to adjust the azimuth scale

Rotate the Azimuth fine adjustment knobs in opposite directions to each other to adjust the azimuth scale of the AM7. It is best to keep the knobs slightly done up to prevent wobble.



### 3.4.3 How to switch the equatorial /alt-azimuth mode

The indicator light being constantly red signifies the equatorial mount mode, while a constant green indicates the altitude-azimuth (alt-az) mode. Before the equatorial mount acquires GPS and time information, the indicator light will remain on for only 5 seconds and then proceed to a flashing state, alternating between red and green.

**Mode switching:** [Reminder: Before switching modes, turn off the equatorial mount and remove any load.]

**To switch from equatorial mount mode to altitude-azimuth mode:**

Connect the hand controller. Long-press and hold the [CANCEL] button, then turn on the AM7. Wait until the indicator light turns green before releasing the [CANCEL] button. Next, adjust the AM7's altitude angle to 90° (for specific operations, refer to section 4.1). The AM7 has now successfully switched to altitude-azimuth mode.

To switch from altitude-azimuth mode to equatorial mount mode: Connect the hand controller. Long-press and hold the [CANCEL] button, then turn on the AM7. Wait until the indicator light turns red before releasing the [CANCEL] button. Next, adjust the AM7's altitude angle to match the latitude value of your location (for specific operations, refer to section 4.1). The AM7 has now successfully switched to equatorial mount mode.

**Note 1:**

After the AM7 is powered on, if the indicator light flashes alternately red and green following a 5-second constant illumination, you need to connect the AM7 to the relevant app or computer to synchronize location and time information. Once the synchronization is successful, the indicator light will revert to displaying the working mode status.

**Note 2:**

After switching modes on the equatorial mount, be sure to tighten the gear position adjustment screw. Otherwise, the device may loosen.

**Note 3:**

When installing the telescope in the altitude-azimuth mode, please position the telescope tube to point to the left side, as shown in the diagram below (when the altitude-azimuth is in the zero

position, the dovetail slot tension knob should be facing upwards). If the telescope is installed in the opposite direction, tracking errors may occur during the GOTO procedure.

### Correct Installation Method



### Incorrect Installation Method



## 3.4.4 How to control the AM7 on PC

Preparation: Power on the equatorial mount, and connect the AM7 to the computer's USB port using the ZWO USB-B to USB-A 2.0 cable.

- (1) Go to the ZWO official website: <https://www.zwoastro.com/downloads> and select [Download].

(2) Click the area marked '1' in the image to download the ASCOM Platform, and then click the area marked '2' to download the ASCOM driver (choose the appropriate version based on your computer's operating system).

**Desktop App**

- Windows
- macOS
- Linux

**Mobile App**

- ASIAIR
- ASIMount
- AstroNet
- ASICap

**Others**

- For Developers

**Windows**

- In order to use the camera, Windows users must install the native driver.
- Please install the **ASCOM Platform** prior to installing the ASCOM driver.
- If you encounter any issues after installing the ASCOM driver, consider installing the required .Net Framework (3.5, 4.5.2).

**ASIStudio**  
ZWO ASI Official astronomy software, specialized in planetary imaging, DSO imaging, live stack and other useful astronomical image processing gadgets.  
V1.9.1 2023-07-20

**Camera Driver**  
Windows users must install a native driver to use ASI cameras.  
V3.22 2023-04-25

**ASCOM Driver**  
After installation, you can control ASI cameras, EAF, EFW, AM5, AM3, and other devices through the ASCOM Platform (pre-installed required).  
V6.5.17 2023-05-23

(3) After the download is complete, install the ASCOM Platform and the ASCOM driver in that order, following the installation prompts to complete the process step by step.

(4) Download and install software applications that support the ASCOM driver, such as ASI Studio, MaxIm DL, NINA, SGP, and other computer software.

In the equatorial mount section of the corresponding software, ① select ASIMount, ② click on [Properties], and a new dialog box will pop up.

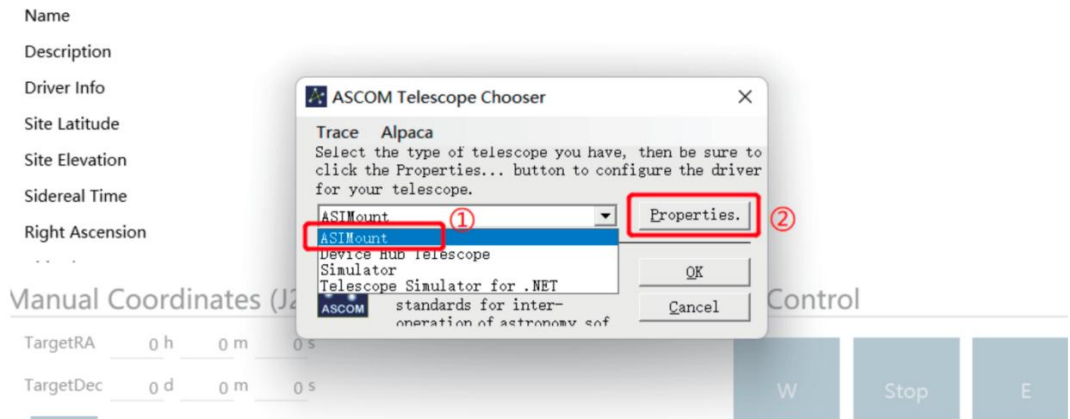

**A.**

① Click on the dropdown menu button in the new window, ② select a port \*, ③ then click on [Connect] to connect the equatorial mount to the computer.

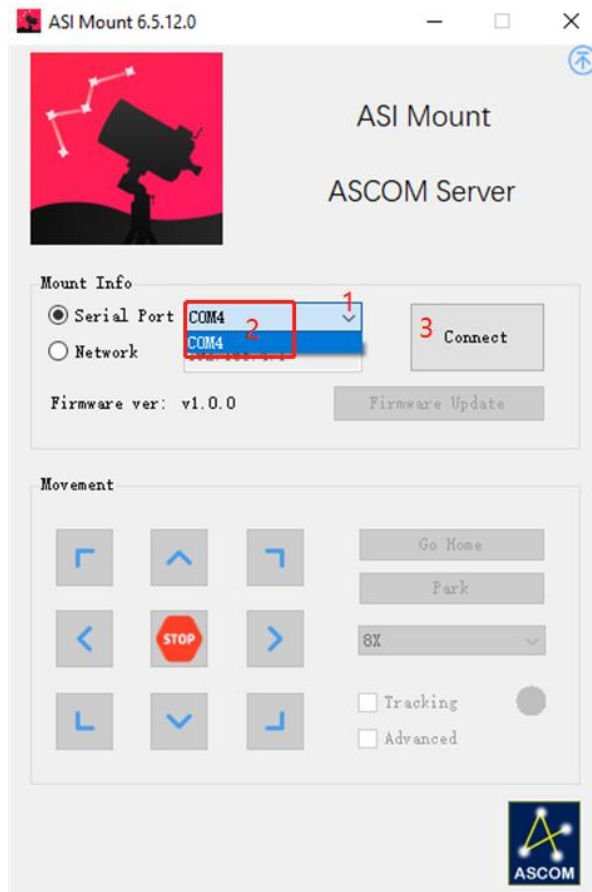

\* **Note:** The port number to select can be found in Computer Management, as shown below; alternatively, you can try each of the serial ports provided in the ASI Mount ASCOM interface one by one.

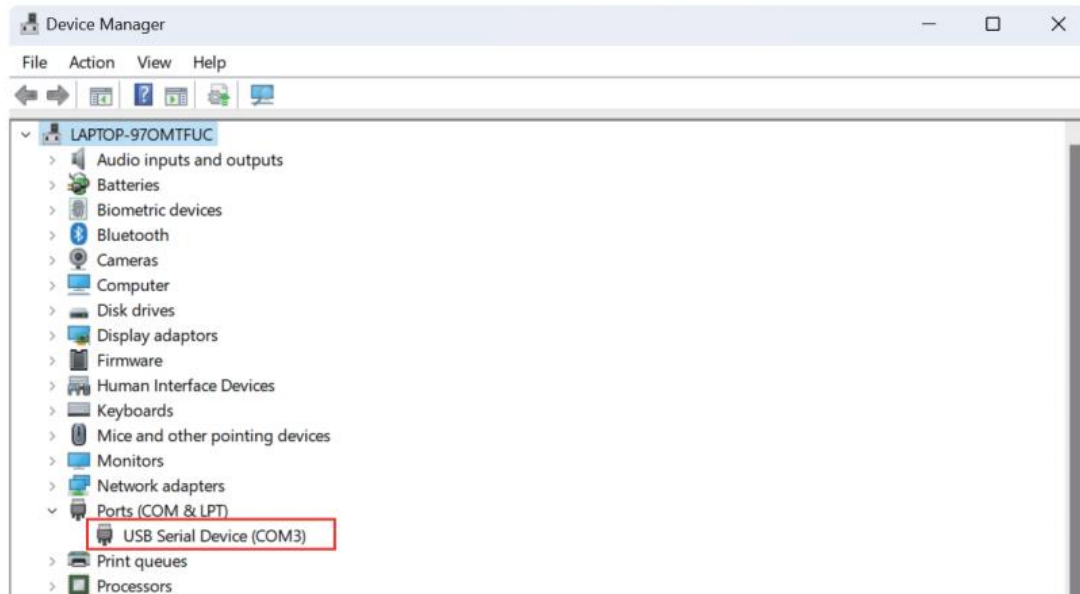

**B.**

Success! Click or long press the directional buttons marked in the image below to control the movement of the AM7.

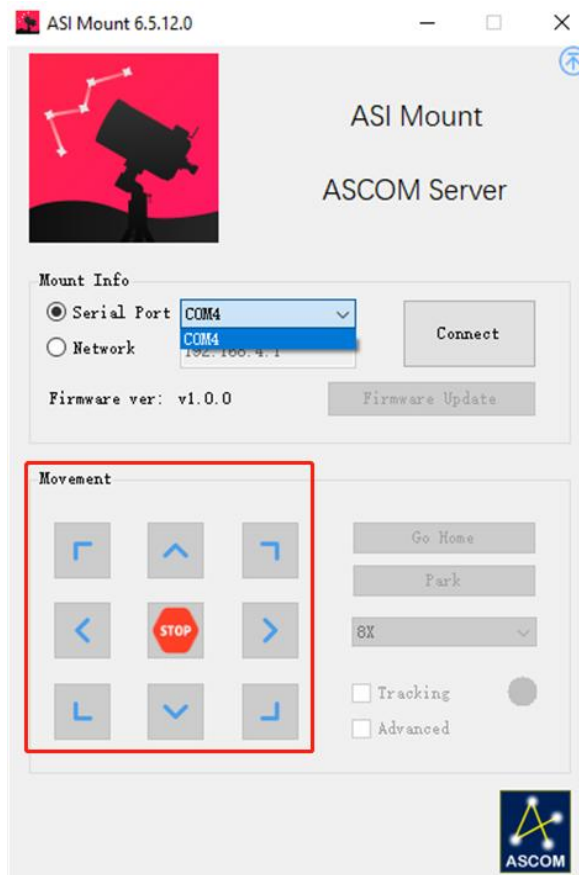

### 3.4.5 How to control the AM7 via ASIAIR

- (1) It is recommended to secure the ASIAIR in a suitable location.



- (2) After powering on the entire system, select the corresponding ASIAIR wireless signal in the mobile phone's wireless local area network (Wi-Fi settings).

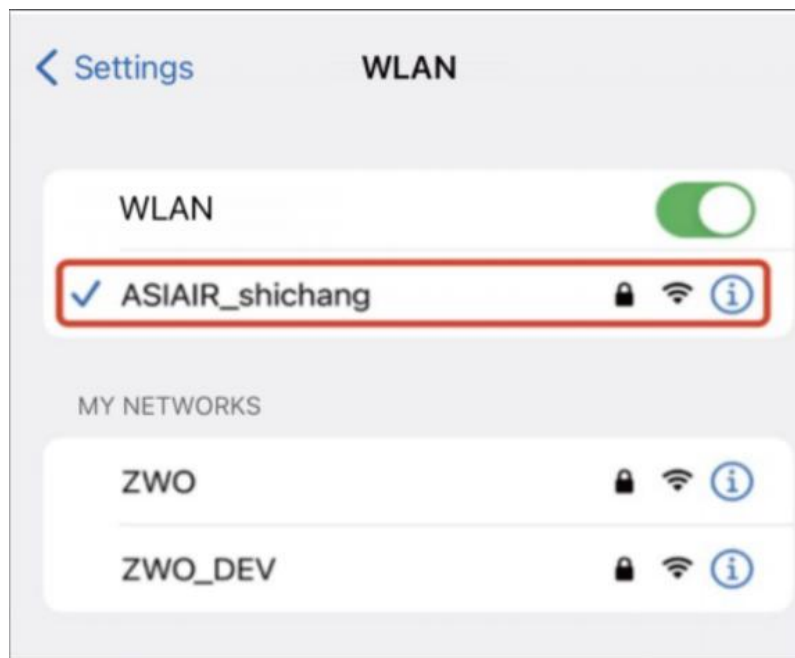

- (3) Open the ASIAIR APP, go to the equatorial mount selection page, choose ZWO AM3/AM5/AM7, and then press the button to start the application (the port will display as connected, and the various parameters of the corresponding equatorial mount will be shown on the page).

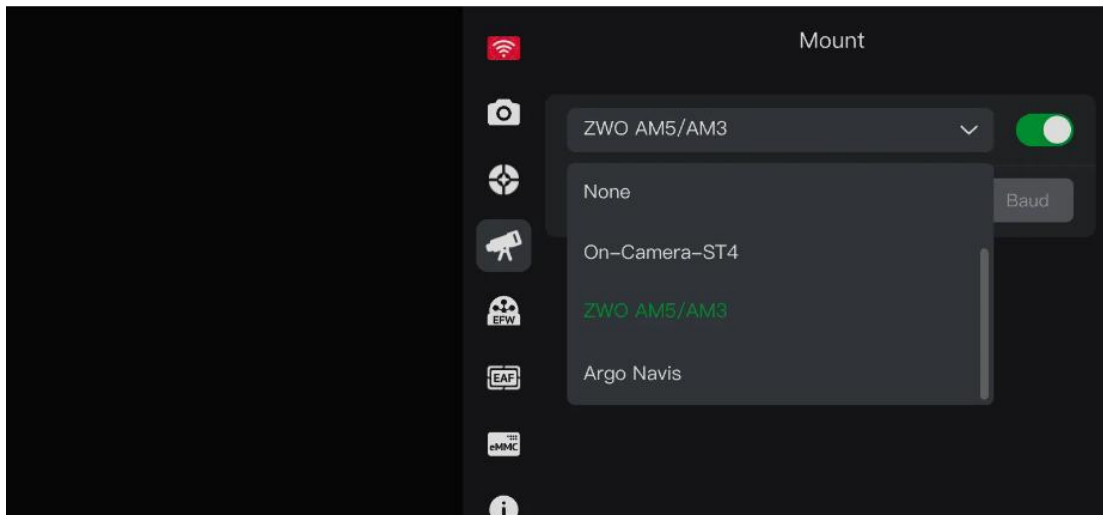

(4) Return to the main page of the APP to set up or activate various devices, and you can control the mount through ASIAIR.



### 3.4.6 How to control the AM7 via Bluetooth/Wi-Fi

(1) Install the SkyAtlas APP

Scan the QR code with your smartphone as shown below to download and install the "Sky Atlas" APP:



(2) How to control the AM7 via Bluetooth

The AM7 unit is equipped with a built-in Bluetooth module, so if you forget to bring the hand controller when you go out, you can control the AM7 through the APP via a Bluetooth connection.

As follow:

**A. AM7 status confirmation:**

Check if the [BT] indicator light on the AM7 unit is constantly lit in blue. A constant blue light indicates that the AM7 is ready to connect. If the light is not constantly blue, it means that the AM7 is currently not connectable. You may check the status of the AM7 and restart it, or press and hold the [BT] button for 5 seconds and then check the status of the indicator light.



**B. Bluetooth connection:**

Start the [SkyAtlas] APP; the homepage is shown as in the following figure. Click the "1" equatorial mount icon to pop up the [Select Connection Method] prompt box, then select "2" [Bluetooth].

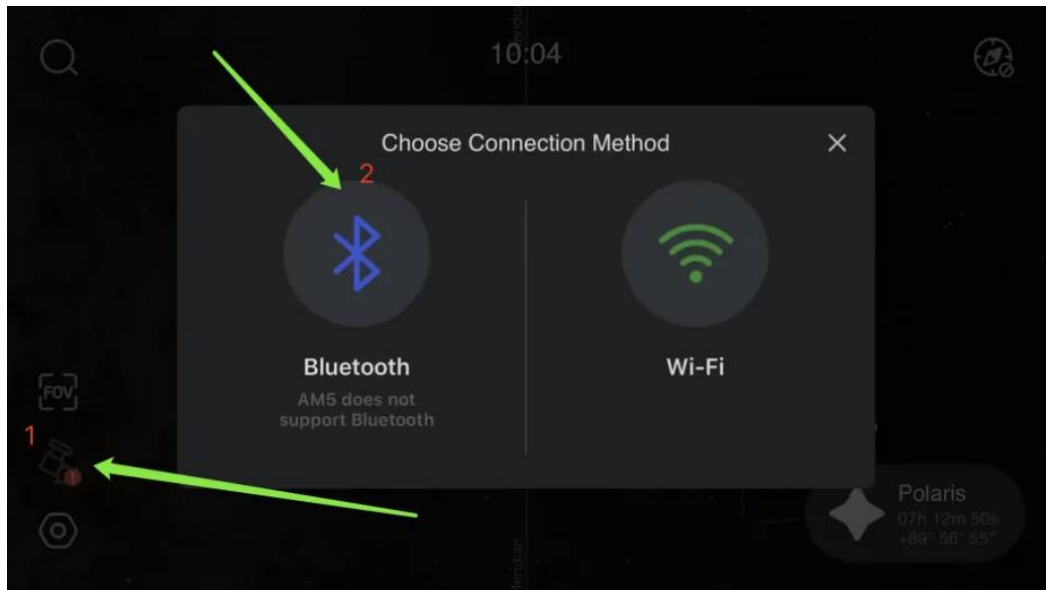

### C. Connection confirmation:

Connect to the required AM7 from the equatorial mount list provided by the APP. During the connection process, when the [BT] indicator light is flashing, you need to click the [BT] button on the AM7 to confirm the device. After the connection is successful, the [BT] indicator light on the AM7 unit will turn off.



### (3) How to control the AM7 via Wi-Fi

Power on the AM7 and turn it on, connect the hand controller, go to the network connection settings page of the mobile device, and select and connect to the Wi-Fi hotspot name of the hand controller such as [AMH\_XXXXXX]. After the connection is successful, return to the APP and upon successful connection, you can control the equatorial mount.

### 3.4.7 How to upgrade the Firmware of AM7

#### (1) Update firmware with APP

Step1:

Open the SkyAtlas APP, and connect to the WiFi of AM7's hand controller.

Step2:

Hit the mount icon to enter the setting page.

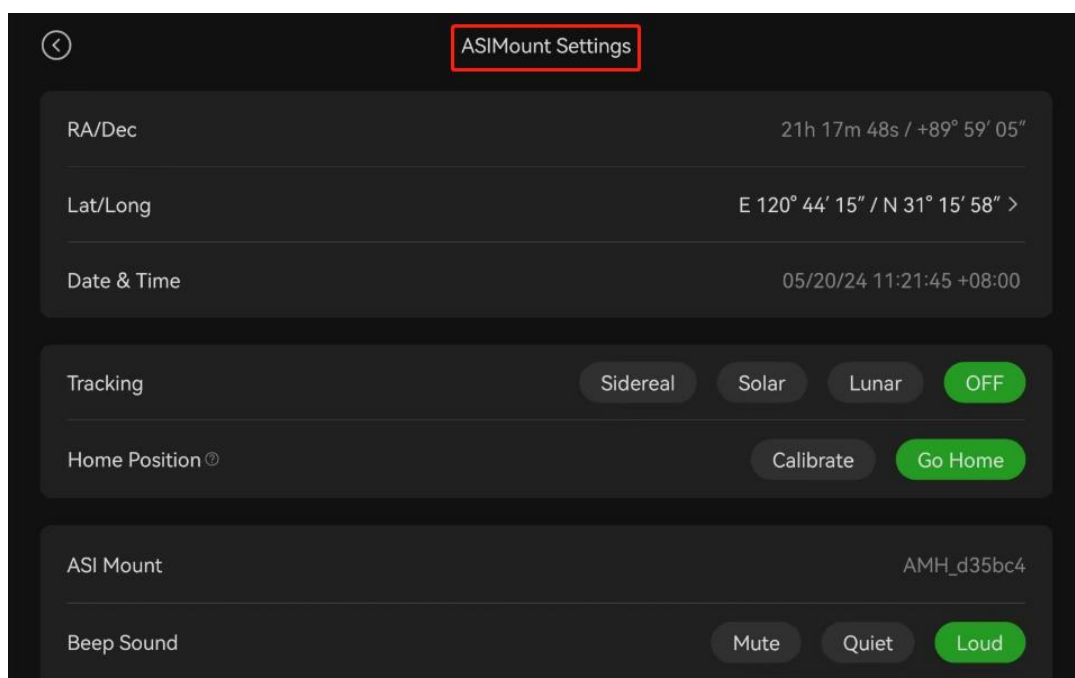
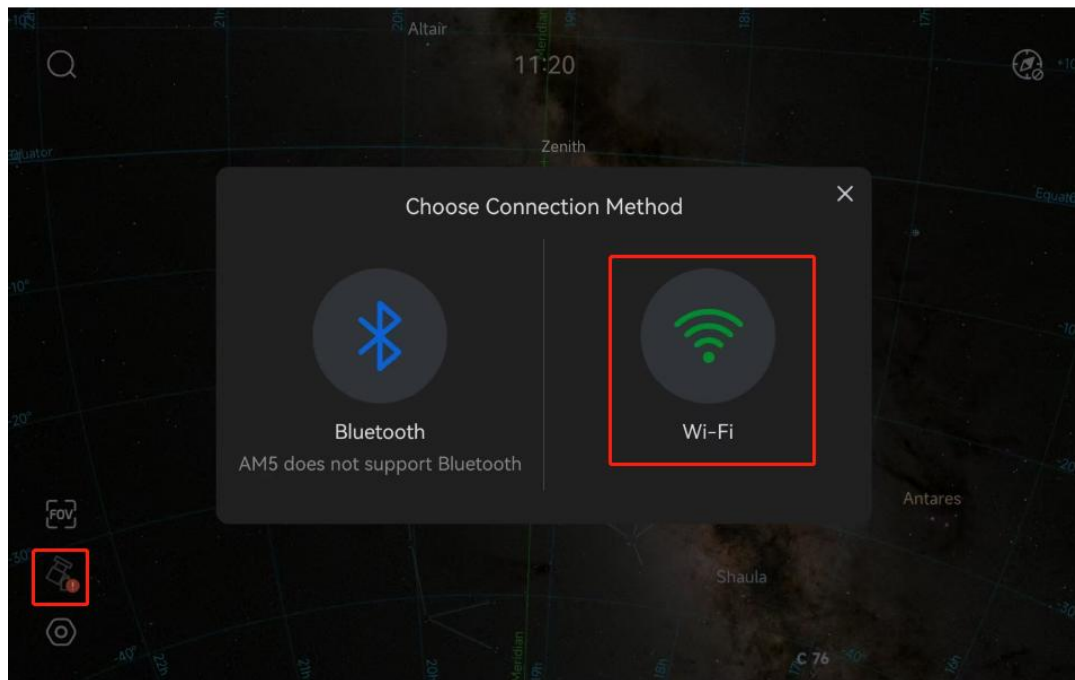

**Step3:**

Hit “AMH Management System” to enter the firmware update page.

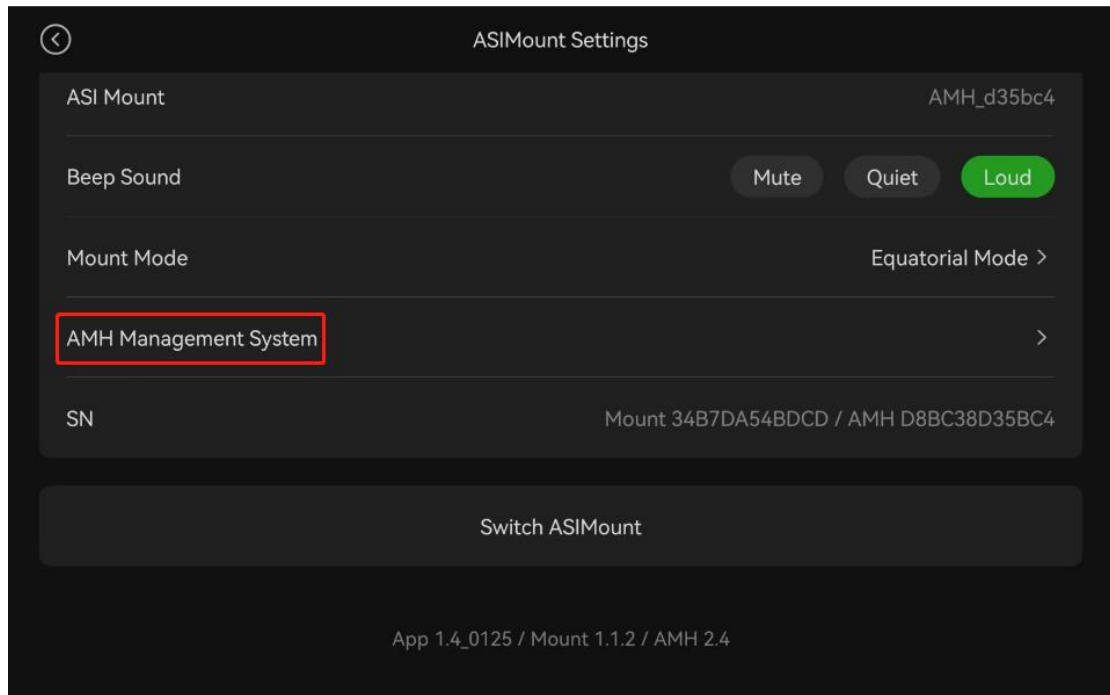

**Step4:**

Enter the “NETWORK” and enable WLAN, to bridge the current AM7 WiFi to your home router network (ZWO\_DEV in our case).

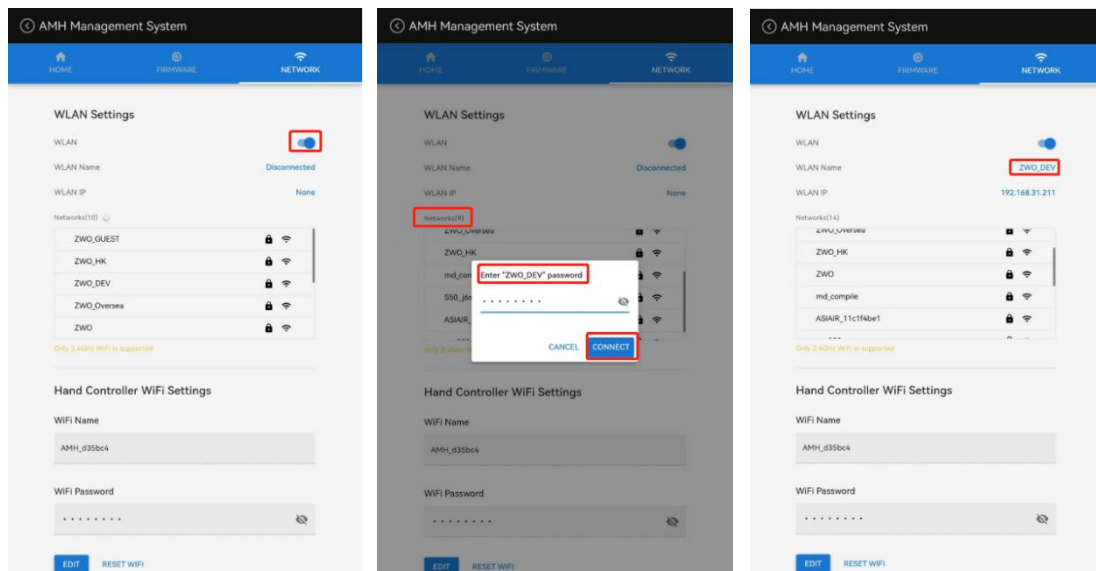

Then hit “FIRMWARE” to update to the latest firmware of the hand controller or the mount.

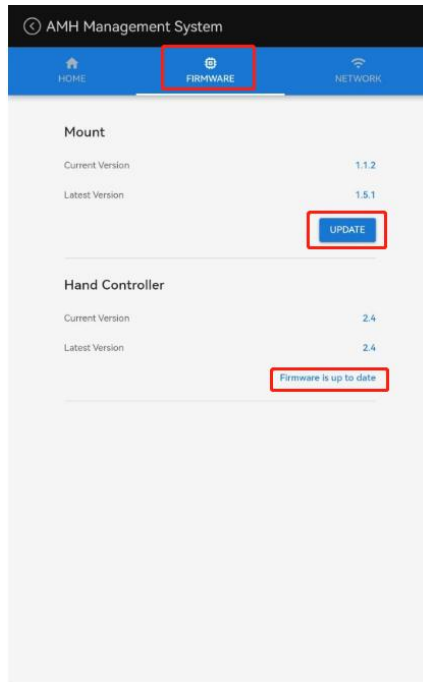

## (2) Update firmware with ASCOM

Open ASCOM platform (please refer to 4.4) and follow the steps below.

Step1: Connect the AM7 to your computer with a USB 2.0 cable.

Step2: Click "Serial Port" and then "Connect" to start communication with your AM7.

Step3: Click "Firmware Update" – "Open File", select the local firmware update file. Note that this file needs to be downloaded in advance.

Or click "Online Update" to download the latest firmware file online.

Step4: Waiting for the firmware update to complete.

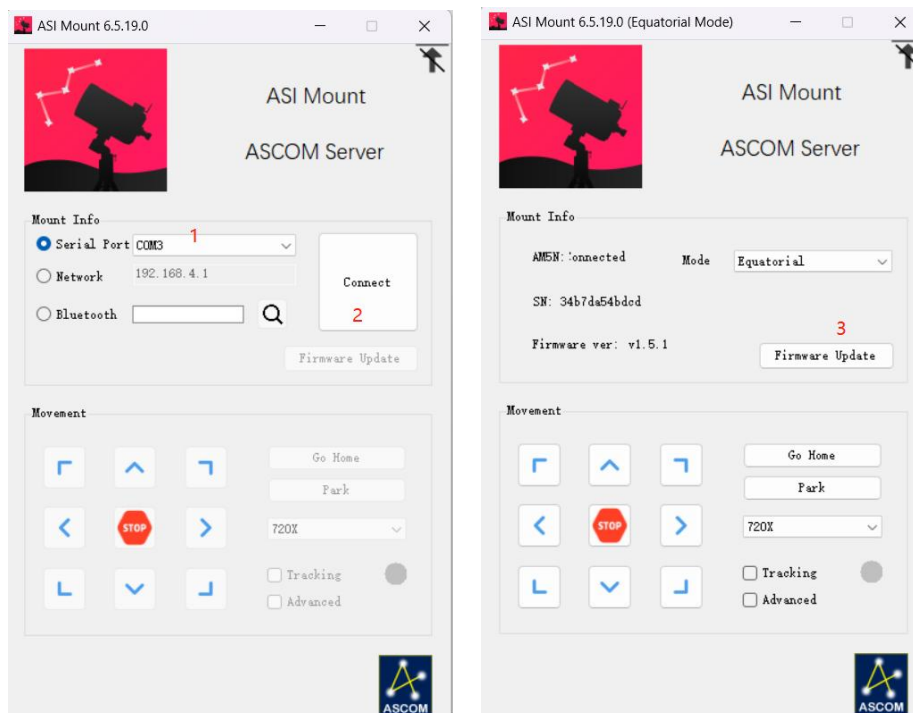

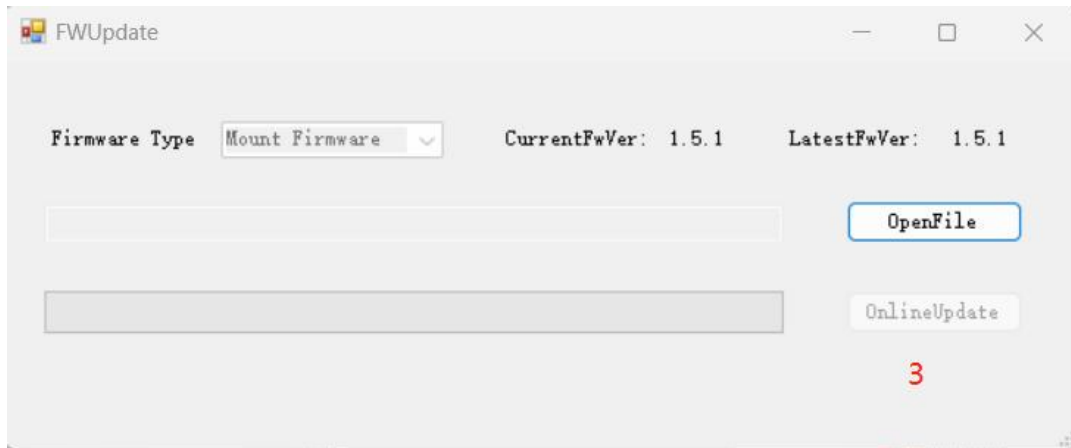

### (3) Update firmware with ASISStudio

Open ASISStudio from your computer and follow the steps below.

Step1:

Connect the AM7 to your computer with a USB 2.0 cable. Be sure it is “Serial Port” that you choose.

Step2:

Click the little arrow icon to enter the firmware update page.

Step3:

Click “Install Manually”, and select the local firmware update file. Note that this file needs to be downloaded in advance.

Or click “Online Update” to download the latest firmware file online.

Step4:

Waiting for the firmware update to complete.

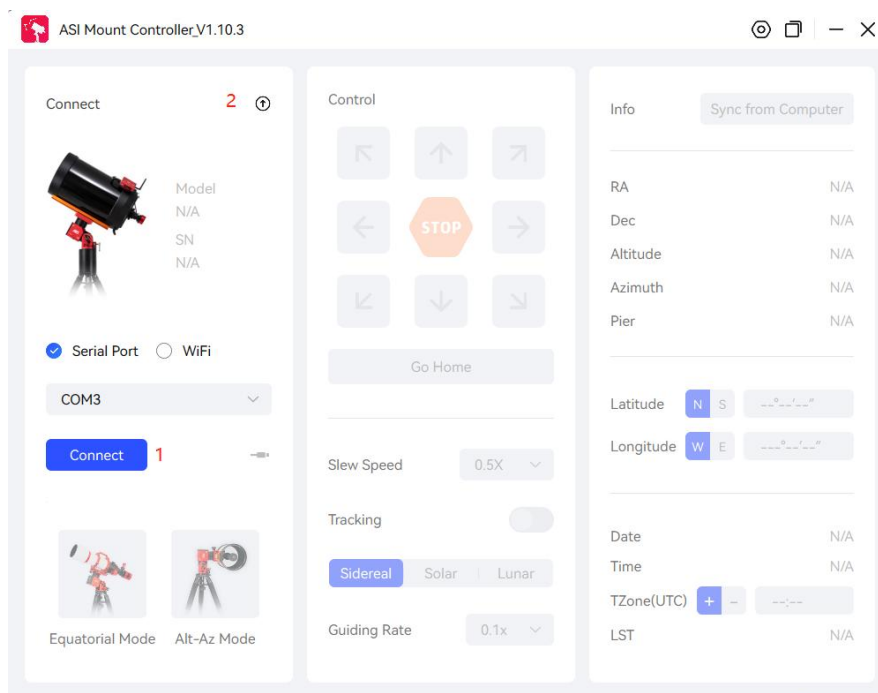

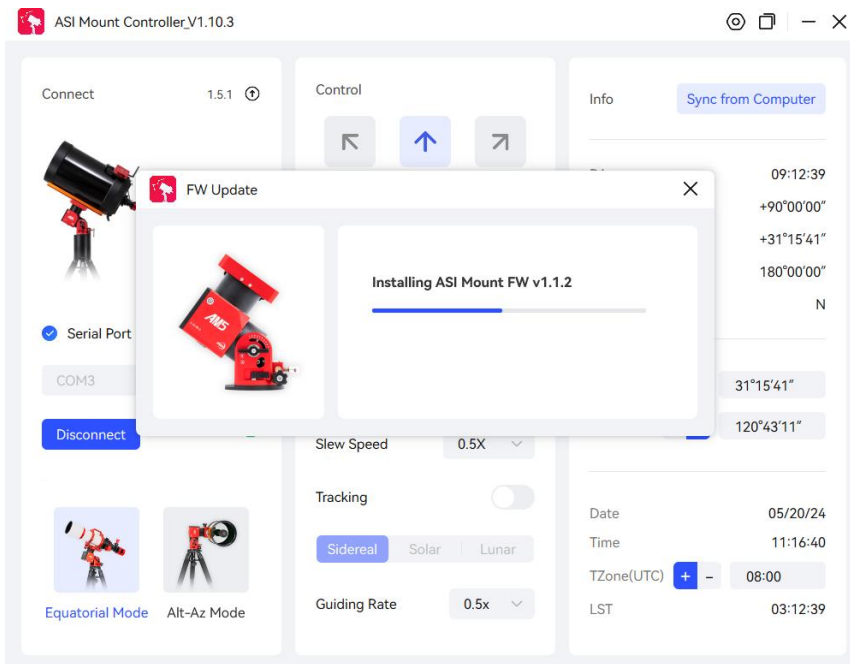
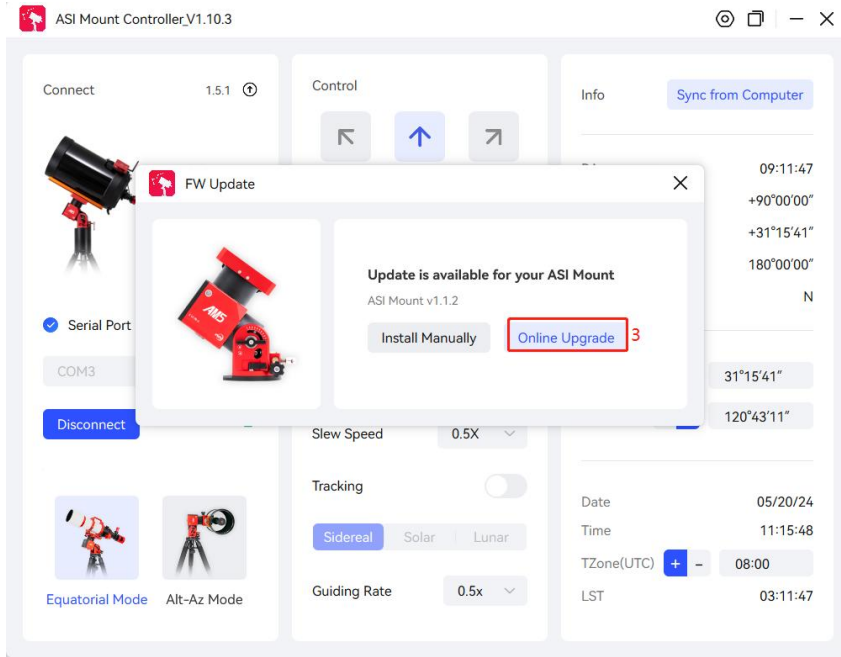

# 4. Structural Dimensions

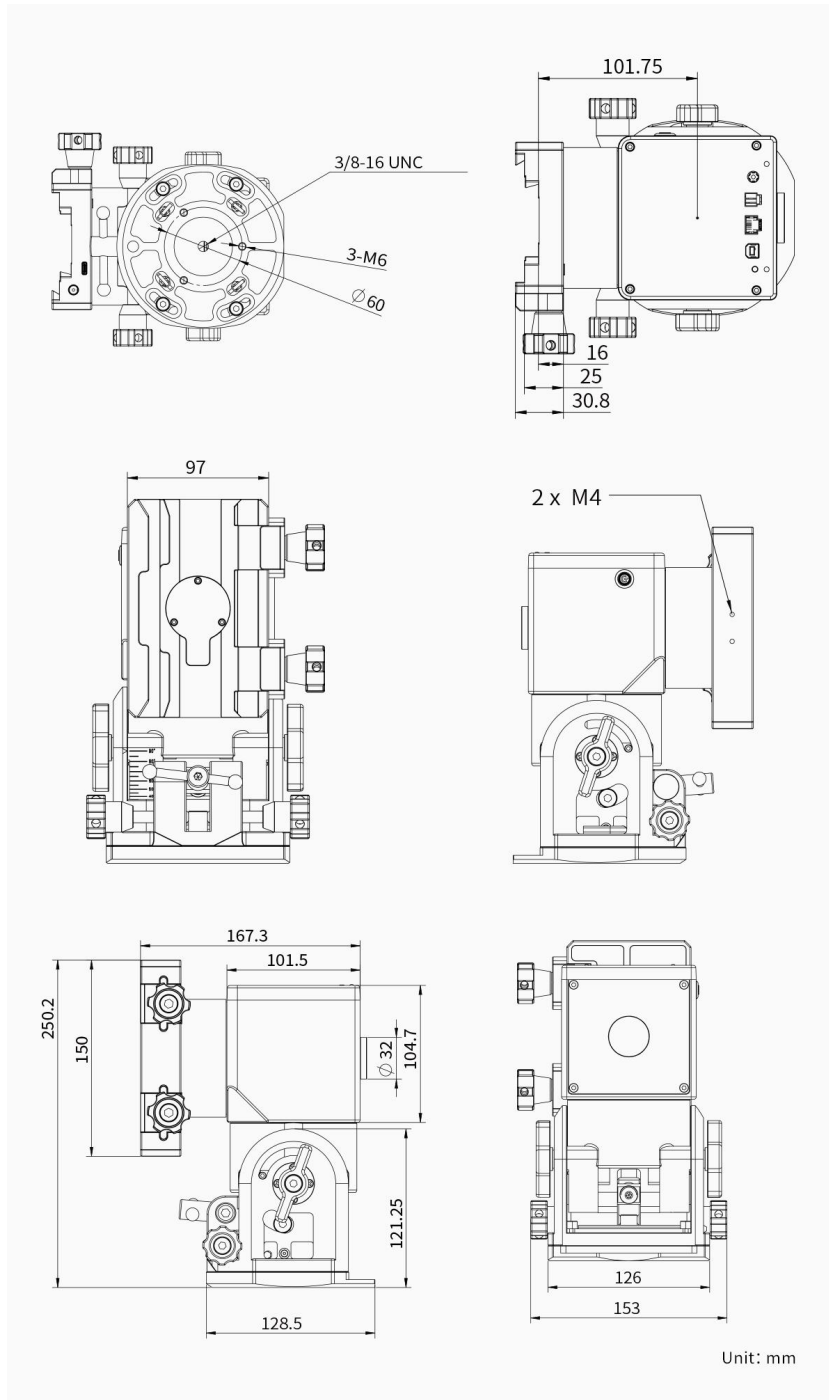

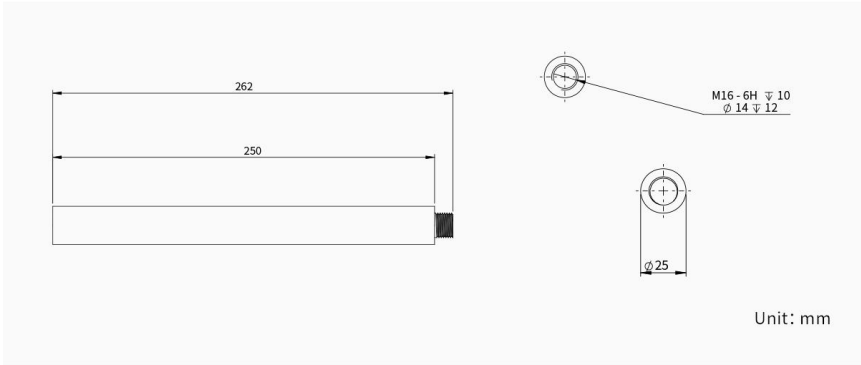
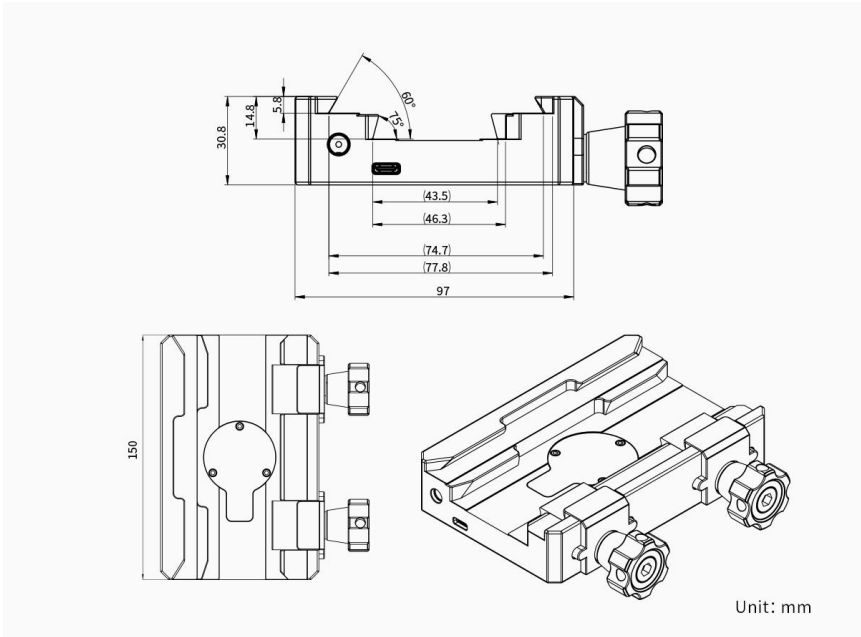

## 5. After Sales

For software upgrades, please download the update directly from the official website, " Official Website Homepage - Technical Support - Software. "

<https://www.zwoastro.com>

For repairs and other services, please get in touch with us:

Email address: [info@zwoptical.com](mailto:info@zwoptical.com)

1. For products usually repaired or replaced within the warranty period, the user will bear the cost of returning them. When sending back the product, the user should note the real cause of the product damage and provide corresponding valid proof, such as pictures or videos. For products that need to be replaced after being confirmed by ZWO in writing, the user should return the fully packaged product with all accessories, manuals, etc., to the address designated by ZWO.

By sending back the product, the user agrees to pay the maintenance fee that may be incurred during the product maintenance process, which is not covered by the warranty service. ZWO will return the product after payment.

2. For products that need to be sent back for after-sales service, ZWO will provide the corresponding RMA code for reference. ZWO will only accept returned products with an RMA number and ZWO's written confirmation.

3. If the user purchased the ZWO product from a ZWO agent, he can directly contact the ZWO agent to obtain relevant after-sales service.

## 6. Warranty

1. ZWO provides a 2-year free warranty service for the products purchased by users from the company, and the warranty period starts from the day after the user receives the product; for AM7 equatorial mount products, the warranty period starts from the activation date of the user's equipment.

2. If the user encounters the following damage-on-arrival (DOA) situations and contacts ZWO within the corresponding period, and issues product purchase invoices and relevant certificates, ZWO will provide free postage service and offer the following products after-sales replacement (or partial replacement), repair or return (or partial return) service:

1) Product quality problem: If you find a quality problem with the product within 180 days from receipt, you can contact ZWO to confirm it has quality problems or defects after testing by the ZWO customer service center. You can get a free replacement service.

2) Product transportation problem: After receiving the product, the user finds that the outer packaging of the product has obvious signs of water soaking or serious backlog and deformation, and shall provide ZWO with pictures of the outer packaging of the product and receipt of the goods within three days from the date of receipt of the product. After verification by the ZWO customer service center, it is confirmed that the product is directly shipped to the user or agent by ZWO, then ZWO will provide relevant return and exchange services; if the product is directly sold or shipped to the user by the ZWO agent, the ZWO agent will be responsible for providing relevant return and exchange services.

3. If the product occurs in the following situations, it is not within the scope of warranty service, and ZWO can provide maintenance services for users:

1) The product exceeds the warranty period;

2) The product is exposed to liquid and corroded by moisture;

3) The product is damaged by external force (such as scratches on the surface, deformation of the product shell, broken USB port, etc.);

4) Dismantling, third-party maintenance, modification and refurbishment, flashing (downloading wrong firmware) without express written authorization from ZWO;

5) The product system is changed, or the warranty label is lost or changed;

6) Product quality problems caused by failure to install according to product usage requirements or instructions;

7) Physical damage and failure of the product caused by irresistible external forces (such as floods, fires, earthquakes, lightning strikes, and other strong vibrations or extrusions);

8) Damage caused by improper user operation during shooting or use;

9) There is no valid product purchase invoice or warranty certificate;

10) The product purchased by the customer is a second-hand product.

Quality problems with accessories or other product parts are not a condition for returning the host, and users can request a replacement of new accessories separately.

## 7. FCC

Any changes or modifications not expressly approved by the party responsible for compliance could void the user's authority to operate the equipment.

This device complies with Part 15 of the FCC Rules. Operation is subject to the following two conditions:

- (1) this device may not cause harmful interference, and
- (2) this device must accept any interference received, including interference that may cause undesired operation.

This transmitter must not be co-located or operating in conjunction with any other antenna or transmitter.

Note: This equipment has been tested and found to comply with the limits for a Class B digital device, pursuant to Part 15 of the FCC Rules. These limits are designed to provide reasonable protection against harmful interference in a residential installation. This equipment generates, uses, and can radiate radio frequency energy, and if not installed and used in accordance with the instructions, may cause harmful interference to radio communications. However, there is no guarantee that interference will not occur in a particular installation. If this equipment does cause harmful interference to radio or television reception, which can be determined by turning the equipment off and on, the user is encouraged to try to correct the interference by one or more of the following measures:

- Reorient or relocate the receiving antenna.
- Increase the separation between the equipment and receiver.
- Connect the equipment into an outlet on a circuit different from that to which the receiver is connected.
- Consult the dealer or an experienced radio/TV technician for help.

\*RF warning for Mobile device: This device complies with FCC radiation exposure limits set forth for an uncontrolled environment. This device should be installed and operated with minimum distance 20cm between the radiator & your body.

## 8. ISED

This device contains licence-exempt transmitter(s)/receiver(s) that comply with Innovation, Science and Economic Development Canada's licence-exempt RSS(s). Operation is subject to the following two conditions:

(1) This device may not cause interference.

(2) This device must accept any interference, including interference that may cause undesired operation of the device.

L'émetteur/récepteur exempt de licence contenu dans le présent appareil est conforme aux CNR d'Innovation, Sciences et Développement économique Canada applicables aux appareils radio exempts de licence. L'exploitation est autorisée aux deux conditions suivantes :

L'appareil ne doit pas produire de brouillage;

L'appareil doit accepter tout brouillage radioélectrique subi, même si le brouillage est susceptible d'en compromettre le fonctionnement.

This transmitter must not be co-located or operating in conjunction with any other antenna or transmitter.

Cet émetteur ne doit pas être colocalisé ou fonctionner en conjonction avec une autre antenne ou un autre émetteur.

The device meets the exemption from the routine evaluation limits in section 2.5 of RSS-102 and compliance with RSS-102 RF exposure, users can obtain Canadian information on RF exposure and compliance.

Le dispositif rencontre l'exemption des limites courantes d'évaluation dans la section 2.5 de RSS 102 et la conformité à l'exposition de RSS-102 rf, utilisateurs peut obtenir l'information canadienne sur l'exposition et la conformité de rf.

This equipment should be installed and operated with a minimum distance of 20 centimeters between the radiator and your body.

Cet émetteur ne doit pas être Co-placé ou ne fonctionnant en même temps qu'aucune autre antenne ou émetteur. Cet équipement devrait être installé et actionné avec une distance minimum de 20 centimètres entre le radiateur et votre corps.