

# Seestar S30

## User Manual



## Table of Contents

Preface .....	2
Important Reminder .....	3
1. Introduce Seestar S30 .....	5
1.1 Introduction .....	5
1.2 Key Features .....	5
1.3 What's in the Box? .....	6
1.4 Specification .....	7
1.5 Components .....	10
2. For First-Time Use .....	13
2.1 Set up Seestar S30 .....	13
2.2 Download Seestar App .....	13
2.3 Start Connection .....	14
2.4 Network Activation .....	16
2.5 Initiating the Connection .....	18
2.6 Firmware Update .....	19
2.7 Using the S30 for Photography .....	20
2.8 Battery Life .....	31
2.9 Power Off and Storage .....	31
3. Accessory Installation and Removal .....	33
3.1 Installing the Solar Filter .....	33
3.2 Battery Removal .....	33
4. Observation/Photography Tips .....	35
5. Structural Dimension Diagram .....	36
6. Disclaimer .....	37
7. After-Sales Service .....	38
8. Warranty Policy .....	39

## **Preface**

Thank you for purchasing the smart telescope Seestar S30. Since ZWO released its first smart telescope, the Seestar S50, in 2023, this product has quickly received astronomy enthusiasts' love due to its ease of use, portability and affordable price. Based on the successful development experience of the first product, ZWO launched a new Seestar - the Seestar S30, a lighter, smarter and more cost-effective smart telescope featuring dual lenses, makes more people accessible to the beautiful starry sky.

Seestar S30 offers an all-in-one solution for astrophotography. It combines an altazimuth mount, telescope, astronomical camera, wide-angle camera, control system, and post-processing tools into a single, sleek device. By using a mobile app, users can quickly aim and track celestial targets, view real-time images through the telescope, and access detailed descriptions of observed targets, making it easy to engage in astronomy observation and educational outreach activities.

This manual is designed to guide users through the proper operation of the smart telescope with clear text and illustrations. It highlights potential improper operations or risky situations. Before using the telescope, please thoroughly read this manual and follow all instructions carefully. Any damage to the equipment or personal injury caused by improper use will be the sole responsibility of the user.

## Important Reminder

This manual provides guidance for safe and efficient use of the Seestar device. Before using the device, please thoroughly read the following reminders and strictly adhere to the instructions during use. This manual may be updated. For the most recent instructions, please refer to the online manual available at <https://www.seestar.com/>

1. Do not observe the sun directly without using the solar filter, as this will cause irreversible damage to the device.
2. Minors must use this product under adult supervision.
3. To charge this device, only use chargers from reputable manufacturers. ZWO is not responsible for damage caused by unqualified chargers. (Charger requirements: supports USB BC1.2; supports 5V 2A in normal mode and up to 12V 3A in fast charge mode).
4. Products that have been disassembled or modified without authorization will not be covered by the warranty.
5. This product is a precision electronic instrument. Do avoid exposure to water or dust, and store it properly when not in use.
6. Do not allow the lens to come into contact with glass windows, fabric, eyeglass cloth, or liquids. Only use specialized optical lens wipes for cleaning.
7. We recommend using the product under an environmental temperature range of -10°C ~ 40°C.
8. Do not use chemical solvents (e.g., alcohol, thinner) or other stratified cleaning fluids to clean the product or its accessories.
9. Keep the product away from open flames to prevent battery explosion.
10. Battery capacity may degrade at lower temperatures due to the natural properties of lithium batteries, which is normal.

11. Store the product in a clean, dry place (recommended storage conditions: temperature below 60°C, humidity below 50%). During thunderstorms or prolonged periods of non-use, please turn off and properly store the device.

12. Do not use the product in weather conditions where wind speeds exceed Force 3 on the Beaufort scale.

## 1. Introduce Seestar S30

### 1.1 Introduction

With its accessibility, lightweight design, and intelligent features, the Seestar S30 simplifies the often complex process of outdoor astrophotography, making it an ideal choice for beginners. Compared to traditional astrophotography equipment, the Seestar series offers unique advantages in terms of cost-effectiveness and operational simplicity. It represents a highly integrated and user-friendly new-style telescope that opens the wonders of the night sky to a broader audience.

### 1.2 Key Features

1. **Lightweight Design:** Integrates multiple hardware components into a single unit, including the telescope, electronic focuser, astronomical camera, wide-angle camera, ASI AIR smart controller, alt-azimuth mount, dew heater, and filter switch tool. Weighing only 1.65 kg.

2. **High-Definition Imaging:** Equipped with a professional apochromatic triplet lens, featuring an ED glass. This setup ensures high color fidelity, sharp focus, and crisp imaging by effectively converging refracted light.

3. **Intelligent Functionality:** Powered by ZWO's proprietary star-finding algorithm, a simple one-click operation enables the built-in telescope to automatically locate, track, plate solve, and focus on celestial targets. The entire imaging process is managed effortlessly through a mobile APP.

4. **Multi-Mode Operation:** Offers Stargazing, Solar System, and Scenery modes to cater to various types of celestial and terrestrial photography.

5. **Dual-Lens System:** Combines an astronomical camera and a wide-angle camera, allowing users to switch between photo and video modes, adapting to different shooting scenarios.

6. **Comprehensive Database:** Includes a robust star database, an encyclopedia of common celestial targets, and intelligent star map guidance for easy navigation.

7. **Global Astronomy Community:** Users can share their work, interact with online friends, and access real-time weather updates in a global astronomy community.

8. **Proprietary System:** Built on ZWO's independently developed motherboard, ensuring stable system performance. This proprietary system, along with ZWO's patented technologies, guarantees precision in imaging and system stability. Continuous APP updates enhance functionality and user experience.

9. **Dual-Band Anti-Light Pollution Filters:** Understanding that many users live in areas with significant light pollution, the Seestar S30 includes dual-band filters (OIII 30nm/Ha 20nm). Users can manually switch to anti-light pollution filters from the APP to improve image quality in challenging environments.

### 1.3 What's in the Box?

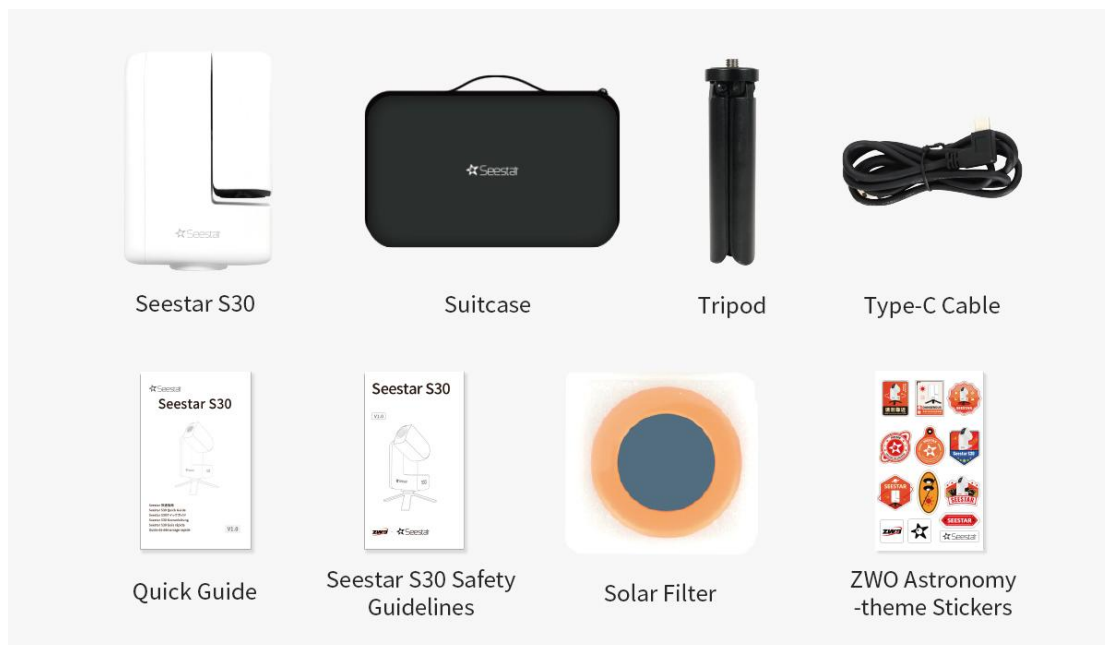

## 1.4 Specification

<b>Product Model</b>	Seestar S30
<b>Sensor</b>	Tele: Sony IMX662
	Wide: Specific sensor for wide-angle lens
<b>Resolution</b>	Tele: 1080 x 1920 ,vertical
	Wide: 1920 x 1080 ,landscape orientation
<b>Field of View</b>	Tele: 2.46°
	Wide: 23.2°
<b>Aperture</b>	Tele: 30mm
<b>Focal Ratio</b>	f/5
<b>Focal Length</b>	150mm
<b>Optical System</b>	Apochromatic
<b>Builtin Filter</b>	UV/IR-Cut Filter Duo-Band Filter (OIII 30nm / H $\alpha$ 20nm) Dark Filter
<b>External Filter</b>	Magnetic adsorption solar filter
<b>Working Distance</b>	6m~∞
<b>Storage Space</b>	64GB eMMC included
<b>Transimission Method</b>	Wi-Fi / USB type-C / Bluetooth
<b>Image Format</b>	JPEG/FITS
<b>Video Format</b>	MP4/AVI
<b>Wi-Fi</b>	5G/ 2.4G
<b>Wi-Fi Effective Transmission Distance*</b>	≤ 10m
<b>Bluetooth Effective</b>	≤ 5m



---

<b>Transmission Distance*</b>	
<b>Working Temperature</b>	-10°C~40°C
<b>Charging Ambient Temperature</b>	0°C~40°C
<b>Storage Temperature</b>	-10°C~60°C
<b>Working Humidity</b>	20%~80%
<b>Storage Humidity</b>	20%~50%
<b>Mount</b>	Alt-Azimuth
<b>Slew Rate</b>	1X- 1440X
<b>Zero Position</b>	Mechanical
<b>Battery Life</b>	6000mAh, Lasts up to 6 hours after a full charge (tested in ZWO laboratory)
<b>Interface on Base</b>	3/8-16
<b>Weight</b>	1.65kg (without tripod)
<b>Power Input</b>	Type-C, Supports DC 5V~12V, 2A~3A
<b>Wi-Fi Reset Button</b>	Support
<b>Dimension</b>	210mm x 140mm x 80mm

\*Transmission distance: The above transmission distance is based on tests conducted in an open environment with no obstacles between devices.

## Battery Specification



<b>Charging Voltage</b>	4.2V
<b>Rated Voltage</b>	3.7V
<b>Rated Capacity</b>	6000mAh
<b>Rated Power</b>	22.2Wh

## 1.5 Components

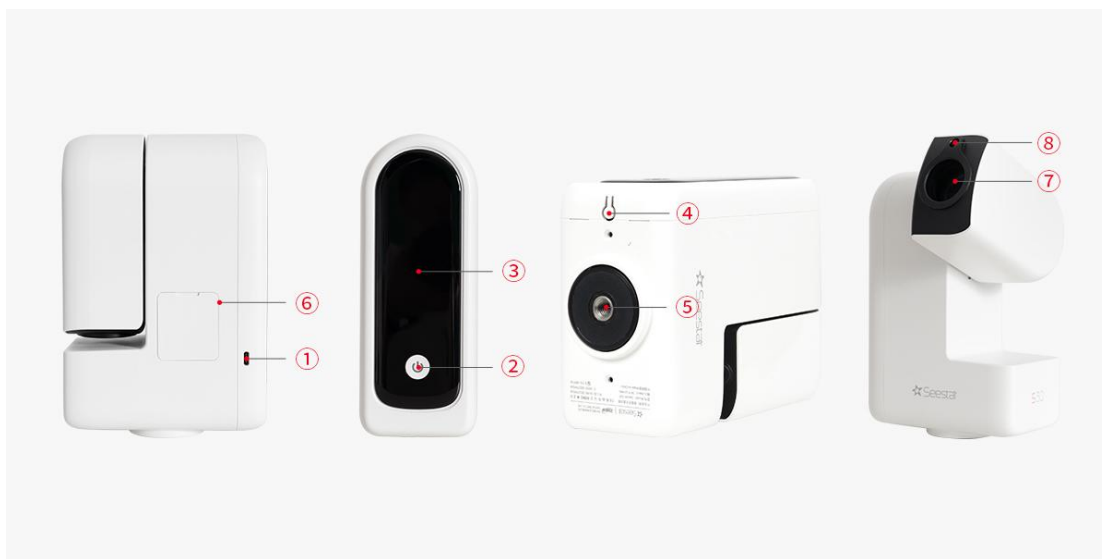

① Charger Port: USB Type-C

② Power Switch

Show battery status	Short press the button while power off
Power on	Long press 2s (Short press 1s and then 2s for first-time use)
Power off	Long press 2s
Forced shutdown	Long press 6s

③ Power indicator and battery indicator

Scene	Power Indicator	Battery Indicator
Check the battery level when the device is powered off	Light off	Light off after showing the battery status
On power	Yellow light on	Battery status : 0-15% battery, red, 1 light blinks 16-25% battery, red, 1 light on 26-50% battery, red, 2 lights on

		51-75% battery, red, 3 lights on 76-100% battery, red, 4 lights on
Boot failure#	Red light blinks	Four lights blink rapidly
Power off	Light off	Light off
Reset Wi-Fi when the device is powered on	While resetting, the yellow power light blinks; After resetting, the yellow power light is on; If fails, the red light blinks	Show the battery status
Switch Wi-Fi when the device is powered on	Red light blinks	Show the battery status
Firmware update when the device is powered on	When the firmware upgrade begins, the yellow light blinks rapidly; once completed, the yellow light blinking stops, and the light returns to its original state.	Show the battery status
Charging, no matter whether the device is powered on or off	Same as power on and power off	0-25% battery, red, the 1st light blinks 26-50% battery, red, the 2nd light blinks 51-75% battery, red, the 1st and 2nd light on, the 3rd light blinks 76-100% battery, red, 4 lights on
Device working	Enhancing (Live stacking): Yellow breathing light on; Others: Yellow light on	Show the battery status
Imaging completed	Normal: Yellow light on Abnormal: Yellow light blinks	Show the battery status

### #Reasons for startup failure and solutions

○ Insufficient device battery: Please fully charge the S30 before attempting to power it on.

○ Other malfunctions: Please contact after-sales technical support.

④ Wi-Fi reset button: Press and hold the Reset button for about 3 seconds to reset the Wi-Fi. If Wi-Fi is not detected after startup, you can reset the Wi-Fi using this method.

⑤ Tripod interface: 3/8"-16 thread

⑥ Battery compartment cover: You can remove the cover to replace the battery.

⑦ Telephoto lens: Supports external magnetic filters. For solar observation, the solar filter must be installed here.

⑧ Wide-angle lens: Features an independent wide-angle camera as well



### **Tripod:**

The small tripod included with the Seestar S30 has a maximum extended height of 52mm and a folded length of 145mm. It features a standard 3/8" screw commonly used in photography tripods, which can be screwed to Seestar S30's base.

The Seestar S30 can also be used with various photography tripods via the 3/8" threaded interface.

Tripod weight: 0.148Kg

Safe load: 5Kg

Tripod material: Aluminum alloy

## 2. For First-Time Use

### 2.1 Set up Seestar S30

Remove the Seestar S30 and accessories from the packaging. Set up the tripod on a flat surface and align the hole at the bottom of the S30 with the 3/8" screw on top of the tripod. Rotate clockwise to securely tighten the S30 to the tripod.



### 2.2 Download Seestar App

The Seestar App is a mobile Application dedicated to the Seestar series of smart telescopes. Through the App, you can capture celestial objects, stack images, perform post-processing, and quickly embark on your astrophotography journey while joining the global astronomy community to share your work!

Scan the QR code below with your phone or visit the App Store to download the Seestar App.



The minimum system and hardware requirements to run the Seestar App:

	Version	RAM	GPU
IOS/iPadOS	13.0 and above		
Android	10.0 and above	6GB	Recommend Adreno 660 840MHz and above

### 2.3 Start Connection

For first-time use, briefly press the power button on the S30 body for 1 second, then press and hold for an additional 2 seconds. You'll hear a "beep-beep" sound and see the power button light up, indicating that the device has successfully powered on. For subsequent uses, simply press and hold the power button for 2 seconds to turn the device on or off.

\*If the battery is too low, the device won't power on, so please connect it to a power source when necessary.

After a few seconds, you will hear the device announce: "Powering on, ready for connection." Bring your smartphone or tablet close to the Seestar S30 and launch the Seestar App (make sure to grant the necessary permissions when using the App for the first time).

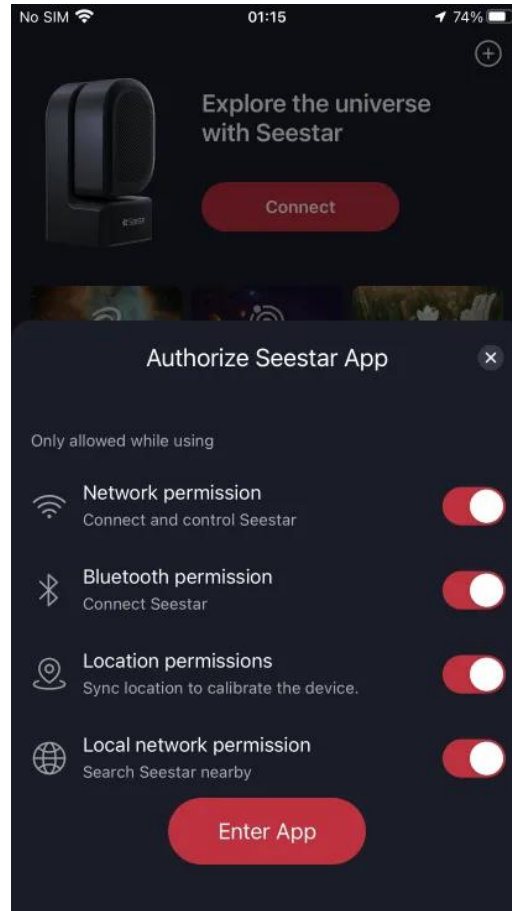

Hit the "Connect" button.

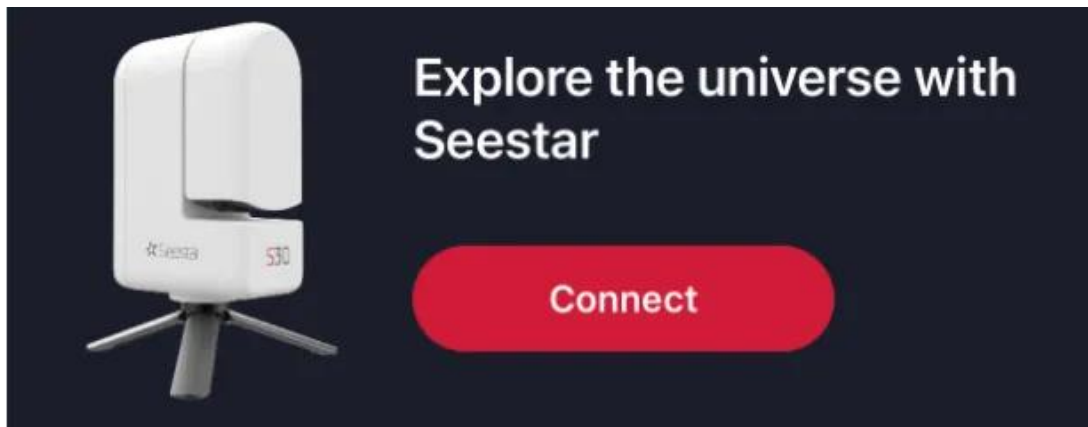

\*Note: Ensure that Bluetooth, device connection, and Network permissions are enabled for the Seestar App to facilitate a smooth connection.

The App will then scan for nearby Seestar S30 devices. Select the S30 you wish to connect to, and tap "Connect".



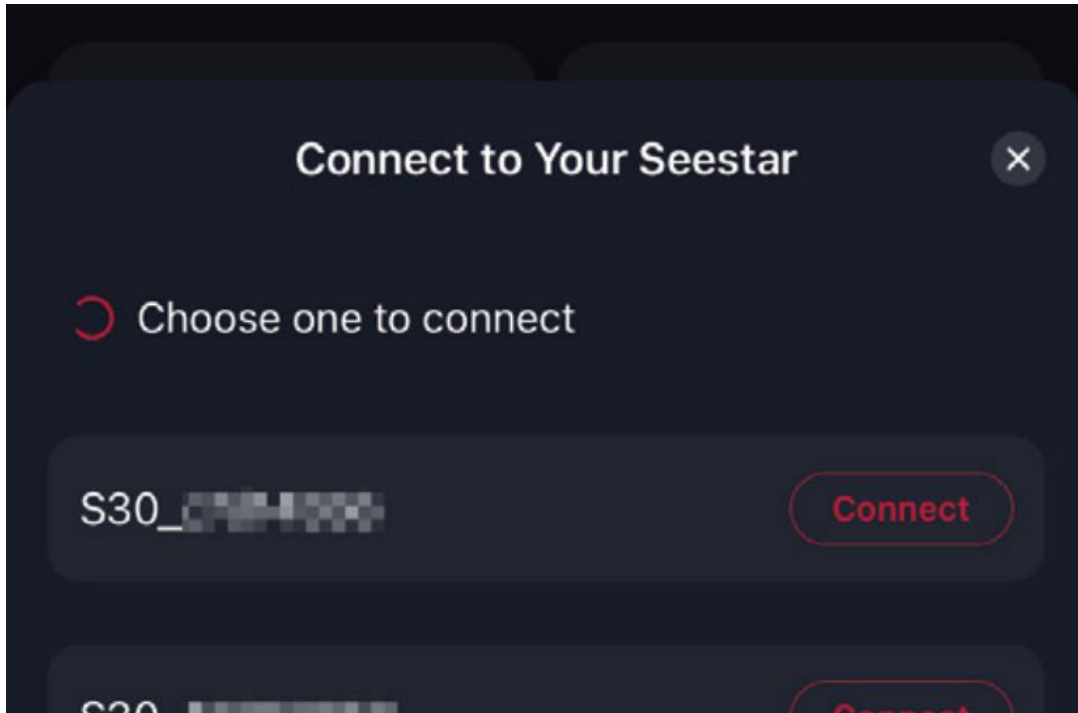

For the first connection, follow the prompts to locate and press the reset button at the bottom of the S30 to confirm the connection.

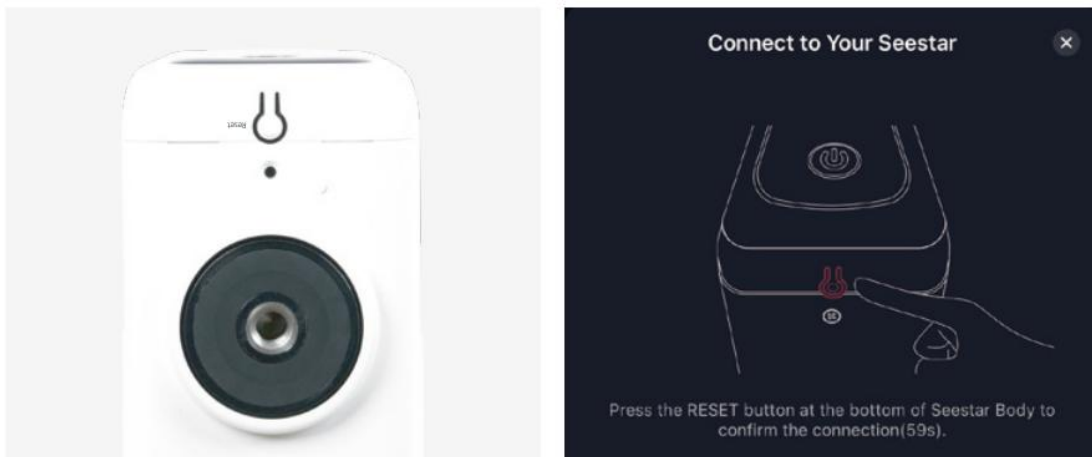

## 2.4 Network Activation

When using the Seestar S30 for the first time, you will need to activate it online. Ensure that your mobile phone or tablet has an active Internet connection to complete the activation process smoothly.

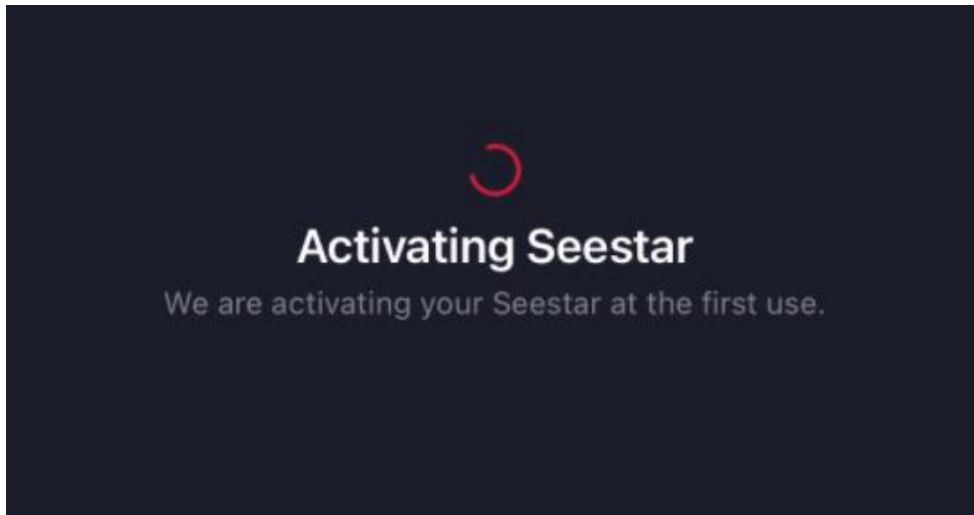

If activation fails midway, verify that your mobile device is connected to a working Network or home Wi-Fi. You can put the Seestar App in the background, manually connect your mobile device to a valid Network, and then return to the Seestar App to tap the "Retry" button and try the activation again.

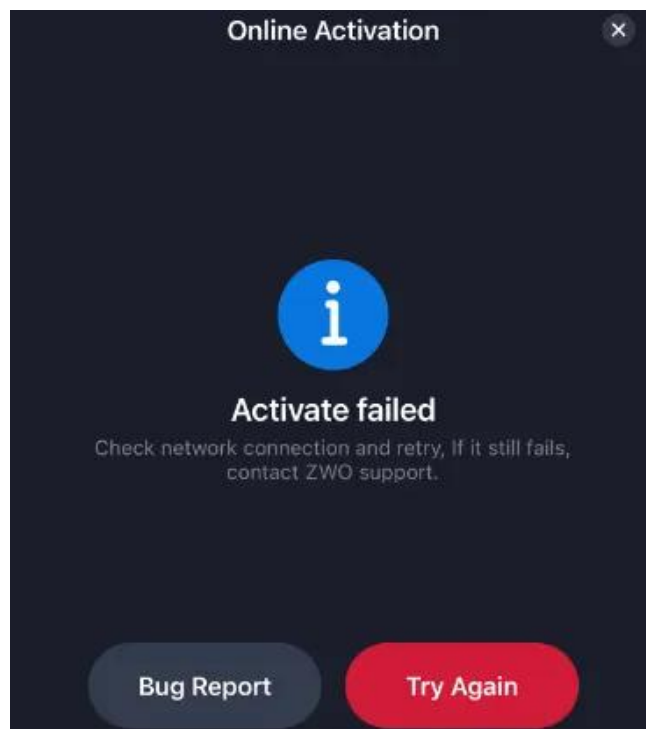

Under normal conditions, the S30 should activate quickly as long as the mobile device is connected to the Internet.

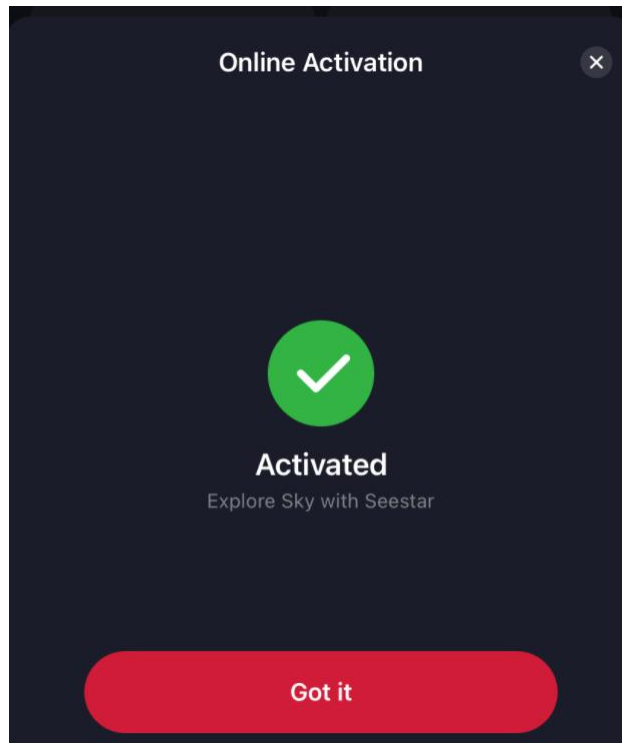

**Important Notes:**

Do not minimize or close the Seestar App during activation.

If activation fails, check your network connection and try again. If the issue persists, please contact customer support.

**2.5 Initiating the Connection**

After successful activation, your mobile device will automatically connect to the Seestar S30's built-in Wi-Fi hotspot. At this point, the mobile Network or home Wi-Fi is no longer required. The Wi-Fi hotspot connection will work even in remote areas without cellular service.

If the connection fails, follow the App prompts to retry or manually connect to the Seestar S30's hotspot.

Tip: Due to the limits of Android operating systems, Android devices cannot automatically connect to the S30's Wi-Fi hotspot and require manual setup. To manually connect, go to your phone or tablet's system settings, select Wi-Fi, and choose the

hotspot with the name of your S30's serial number (e.g., S30\_XXXXXX). The default password is **12345678**.

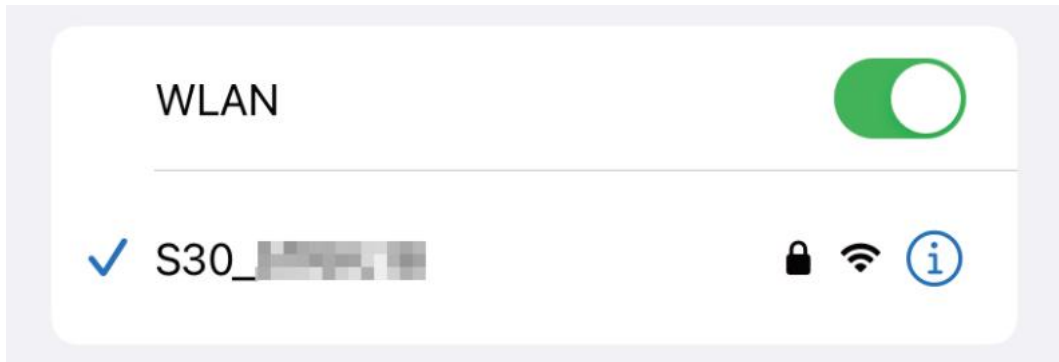

## 2.6 Firmware Update

Once your mobile device is successfully connected to the Seestar S30, if a firmware update is prompted, please follow the instructions to allow the update. Wait for the update process to complete before using the device. After the firmware update is finished, the S30 will automatically reboot.

If there is no firmware update prompt, you can skip this step.

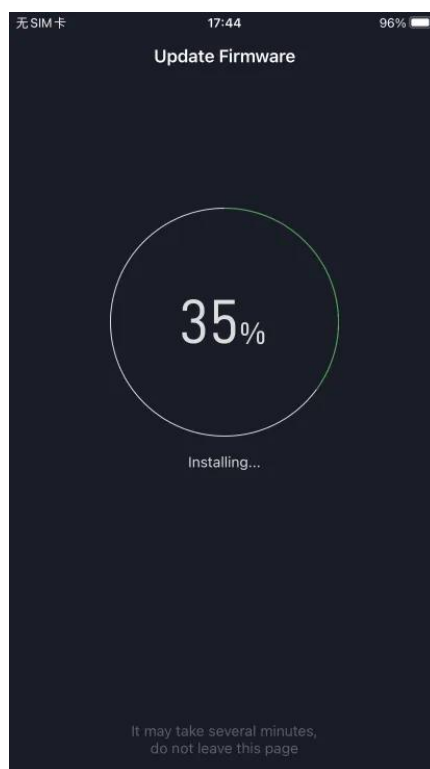

## 2.7 Using the S30 for Photography

Below are instructions for both deep space and solar photography.

### Deep Space Object Photography (Best Conducted at Night)

After connecting the Seestar App to your Seestar S30, select "Stargazing" on the homepage.

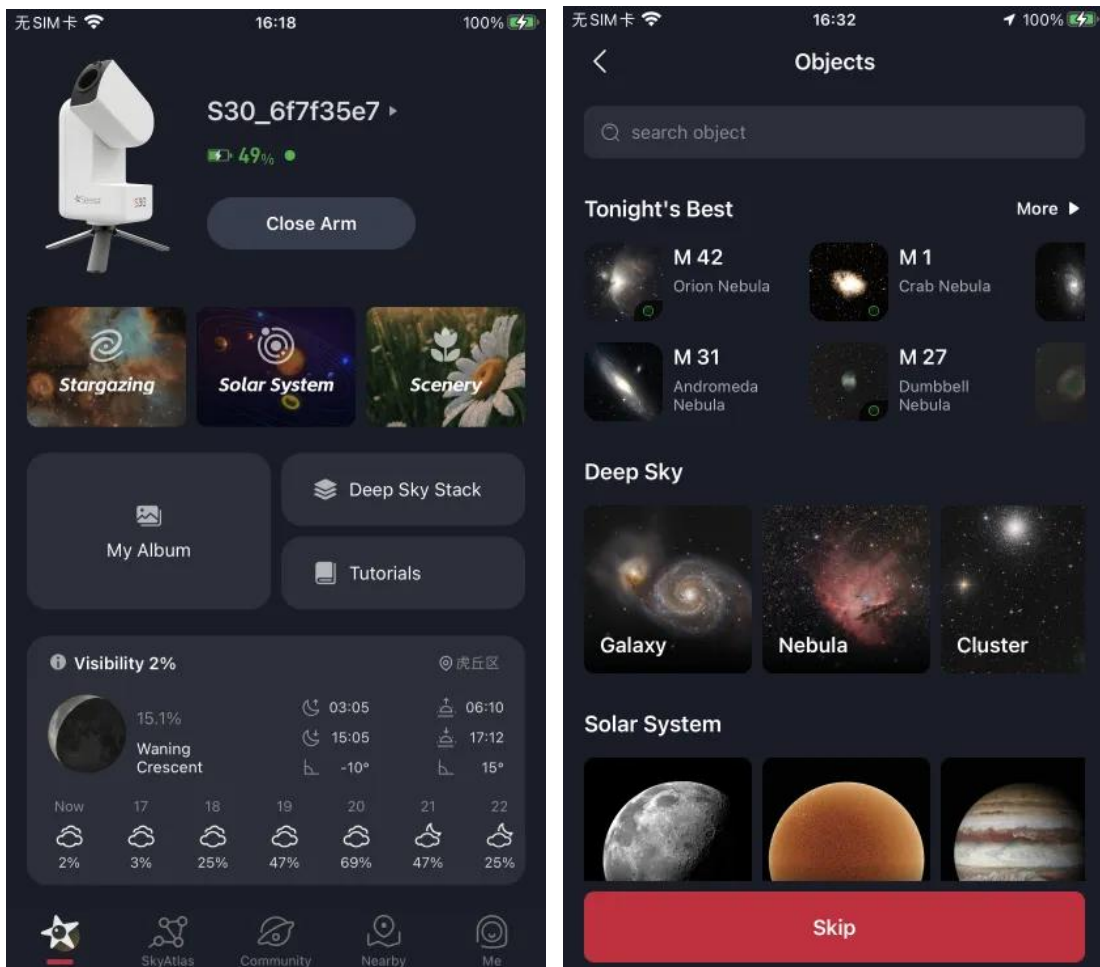

On the next page, the system will recommend "Tonight's Best" objects. It will also show the full list of deep space and solar system objects. You may choose one from these categories for imaging or observation.

Scroll up and down the list to find a target with a relatively high "Current Altitude." Click the "GOTO" button next to your selected target, and the telescope will slew toward it.

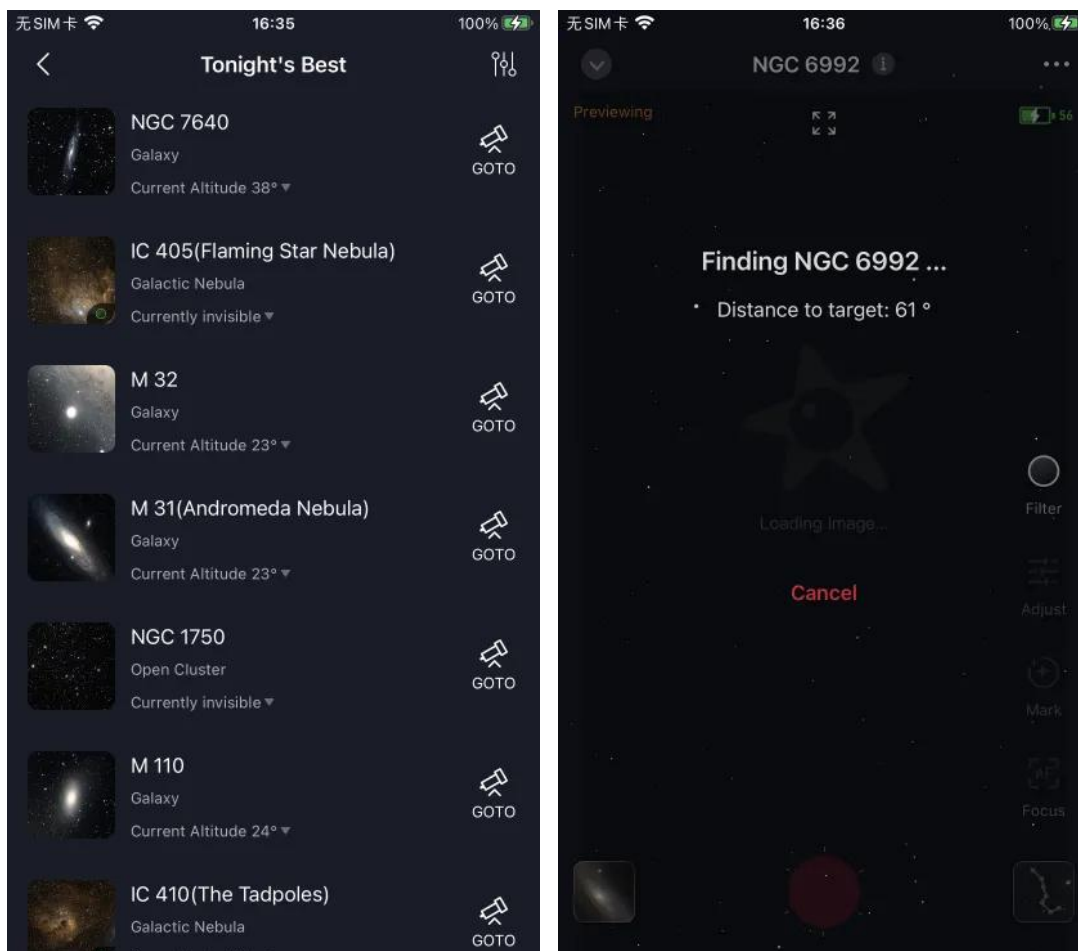

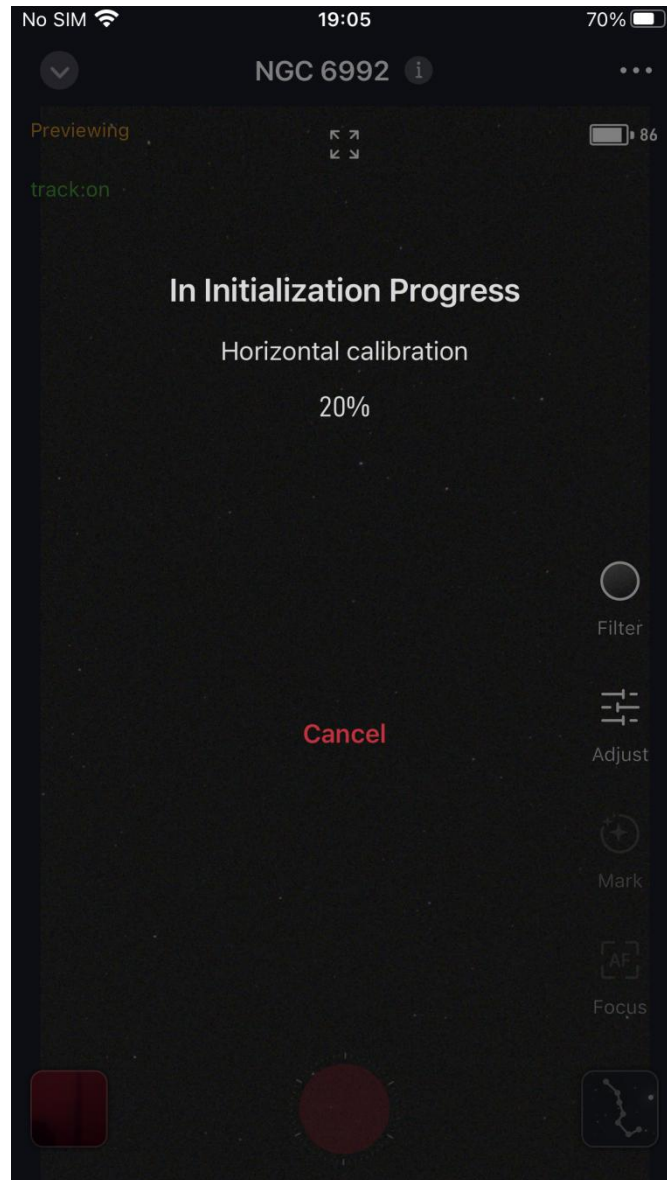

As the telescope moves, you'll notice the angle from the object decreasing, indicating that the device getting closer to the target.

After a short wait, the telescope lens will lock onto the target, and then S30 will begin its automatic initialization process, which prepares for subsequent photography. (This initialization occurs only once after powering on the S30; subsequent sessions won't trigger this step.)

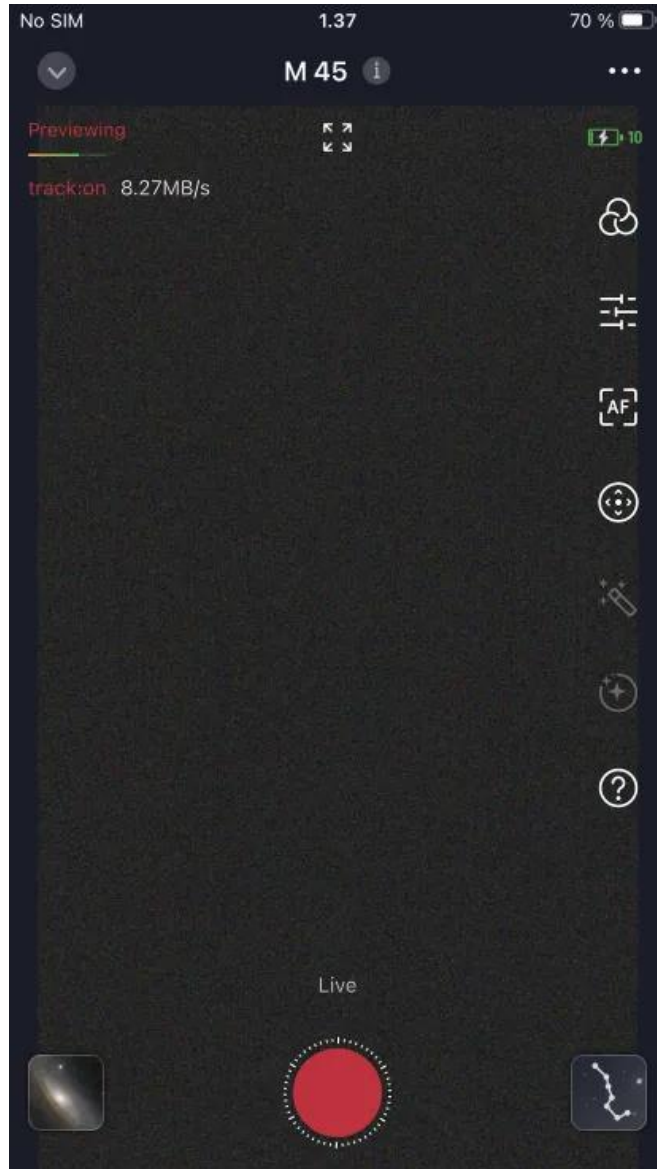

Once initialization is complete, the S30 will automatically start imaging. By default, the Seestar S30 captures 10-second exposure frames and stacks them. You can watch the image gradually getting sharpened in the App. (The waiting time for clear images depends on weather conditions, light pollution, etc.) While it's imaging, you can exit the App and do other things. The Seestar S30 will continue the current imaging task, even if the mobile device disconnects. You can reconnect the App later to view the latest progress.



Once you're satisfied with the quality of the stacked image, click the "Stop"  button to end the session. Congratulations, you've successfully captured a deep space object with your S30 !

To export the image to your phone, open the album in the bottom left corner of the imaging page. Switch to the "Seestar" tab at the top to view the images stored on the Seestar S30 device. Find the folder with the target you just captured, and open it.



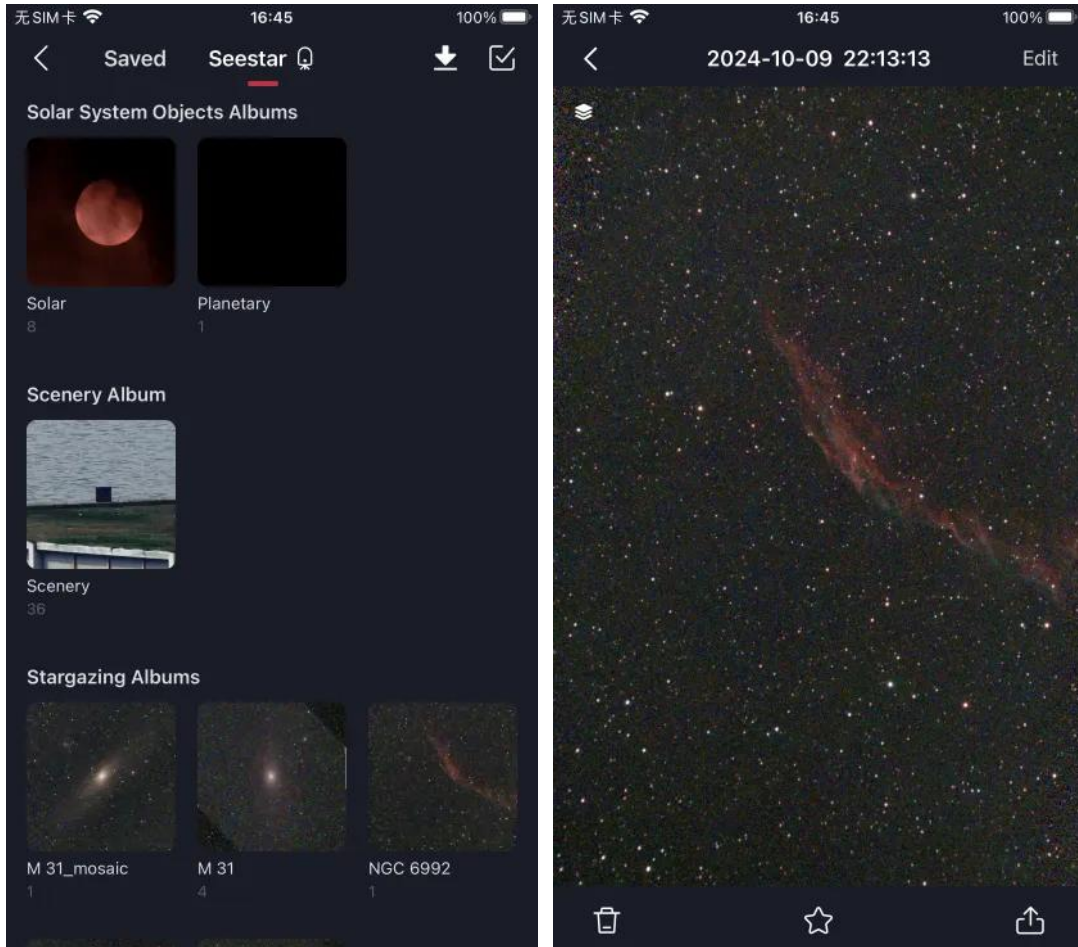

Click on the image you just took to view it. 

Hit the "Share" button and then select "Download to local" from the bottom menu.

This will save the image to your phone's gallery for quick access.

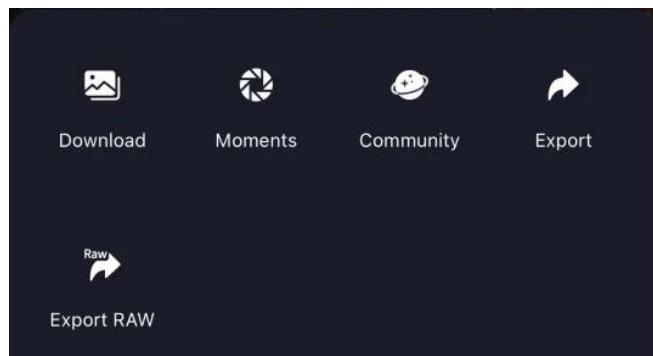

View the target photos you've captured in your phone's gallery, you may share them on social media or in the App's community to share your special stargazing experience with fellow astronomy enthusiasts.

\*Tip: You can also quickly share your photos directly to the App's community from the Seestar gallery.

Once done, you can continue to observe other celestial targets or power off the device and store it away.

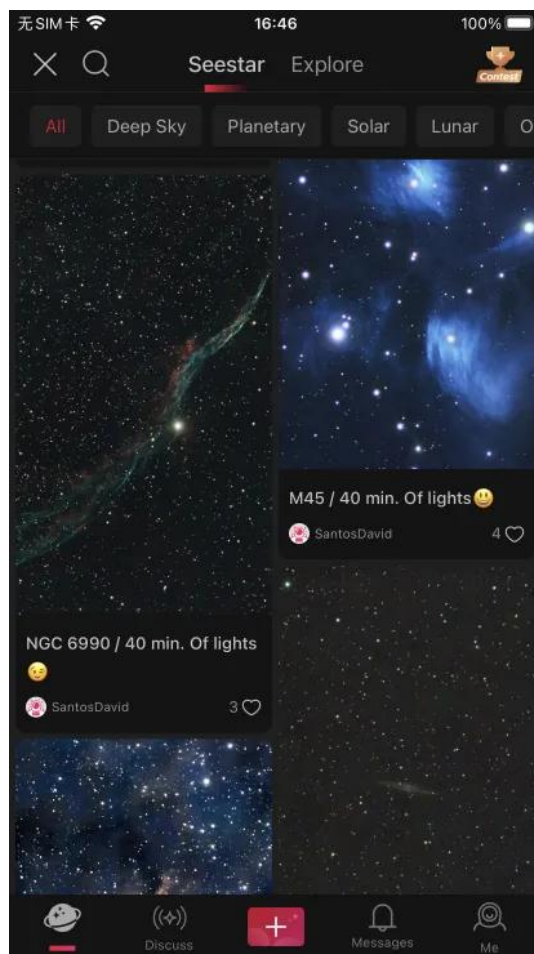

### **Solar Imaging (Best Conducted at Daylight)**

Note: Before starting to capture the Sun, make sure to properly install the included solar filter. Do not proceed with the following steps without it!

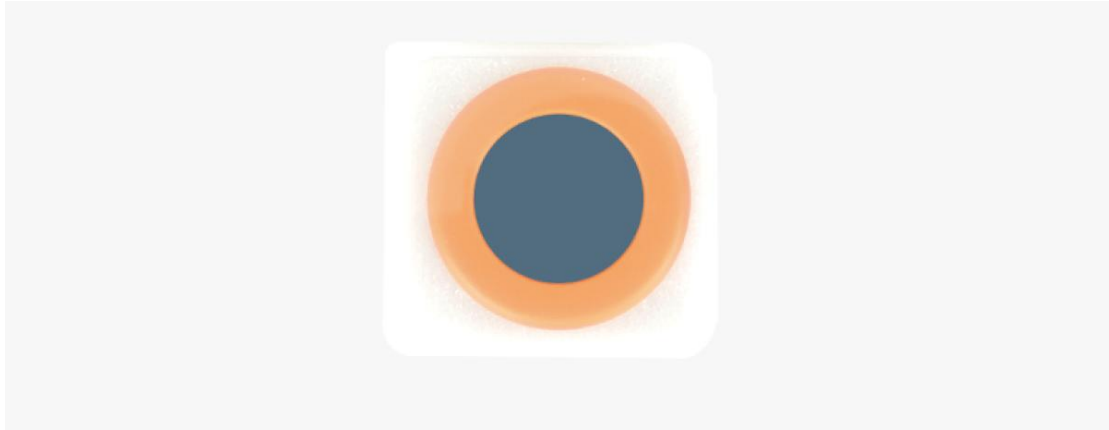

Once Seestar App is connected to Seestar S30, go to the home page and select "Solar System."



In the Solar System targets, select Sun, then click GOTO (ensure the Sun is visible in the sky). The lens will lift to a certain angle and stop. At this point, please follow the

instructions in the App to install the solar filter onto the telescope lens. After installation, click "Installed & Shooting," and S30 will continue its GOTO to the Sun.

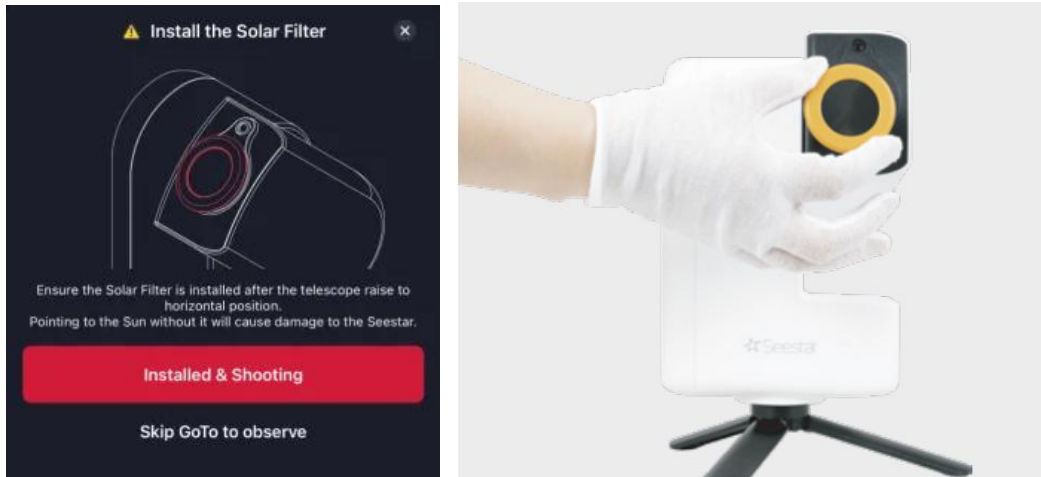

To ensure maximum safety for both you and the device, auto GOTO will stop once the lens roughly points at the Sun. Follow the App's instructions and manually adjust the lens to point directly at the Sun.

Important: Before proceeding, please confirm the solar filter is securely installed on the telescope lens.

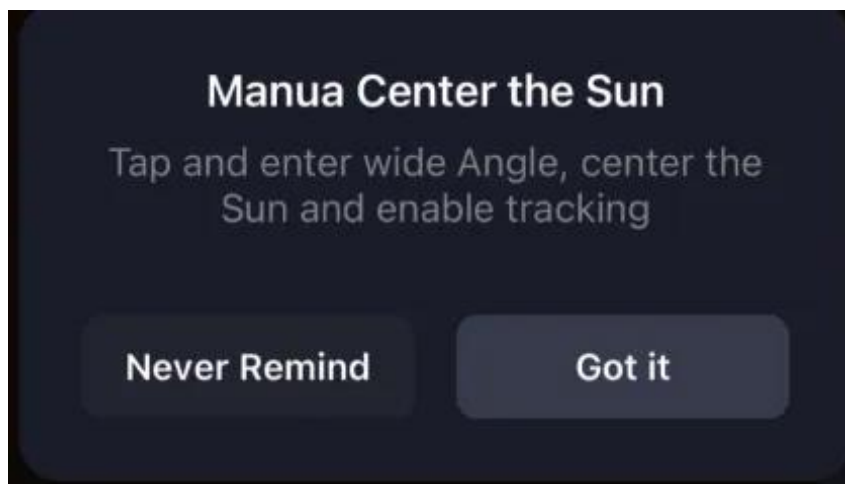

You may also use the manual method to find the Sun:

- If you cannot see the Sun's light in the telephoto view: Use the "GO" target feature in wide-angle view to bring the lens closer to the Sun, then use the virtual joystick to

fine-tune the alignment. Here's how: Switch to the wide-angle view, hit once on the brightest point of the Sun, and the "GO" icon will Appear. Hit again, and Seestar S30 will slew towards the targeted point. Repeat this process until the Sun is visible in the telephoto view.

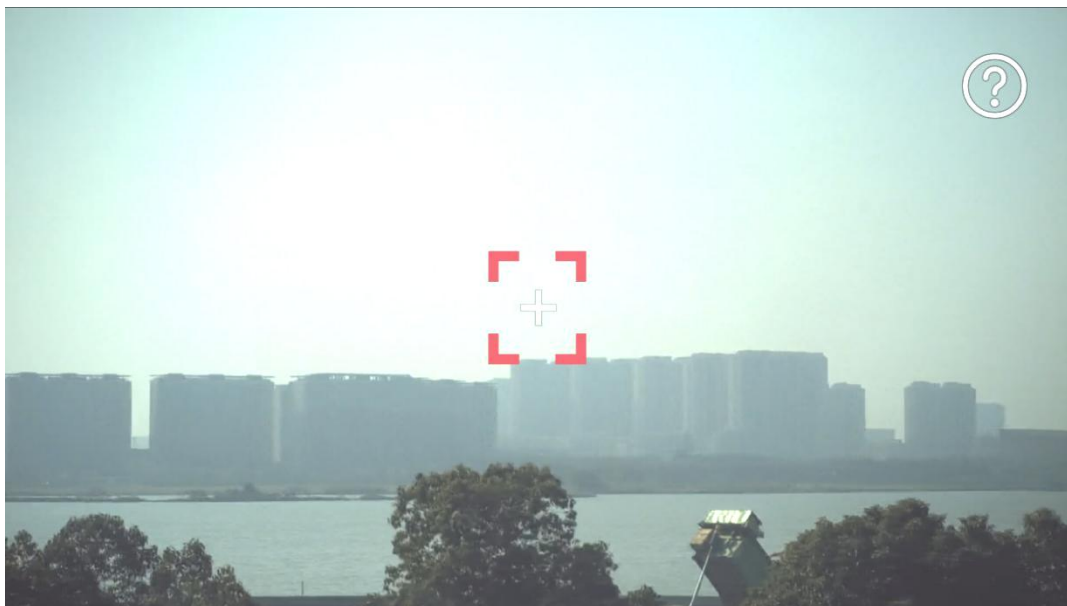

- If the solar light becomes visible in the telephoto view after Auto GOTO or multiple "GO" attempts, switch to the telephoto view. Activate the virtual joystick, set it to "Slow"

speed, and manually adjust the lens to align with the Sun. Once aligned, you will see the Sun clearly in the telephoto view.



Choose the suitable magnification levels (1x/2x/4x) to observe the Sun, choose the appropriate field of view, and tap the circular button below to capture a photo.

After successfully photographing the Sun, if you wish to end the solar observation, use the virtual joystick to move the Sun out of the telephoto view. Only then should you remove the solar filter from the lens. Congratulations, you've successfully captured the Sun using the S30!

Caution: Never point the lens directly at the Sun without the solar filter installed.

Next, let's view the photos you've just captured.

Open the album at the bottom left of the imaging interface, and switch the album tab at the top to "Saved" to view images taken with the S30. (For videos, navigate to the "Seestar" tab.) Locate the folder named with the date of the current session and open it.

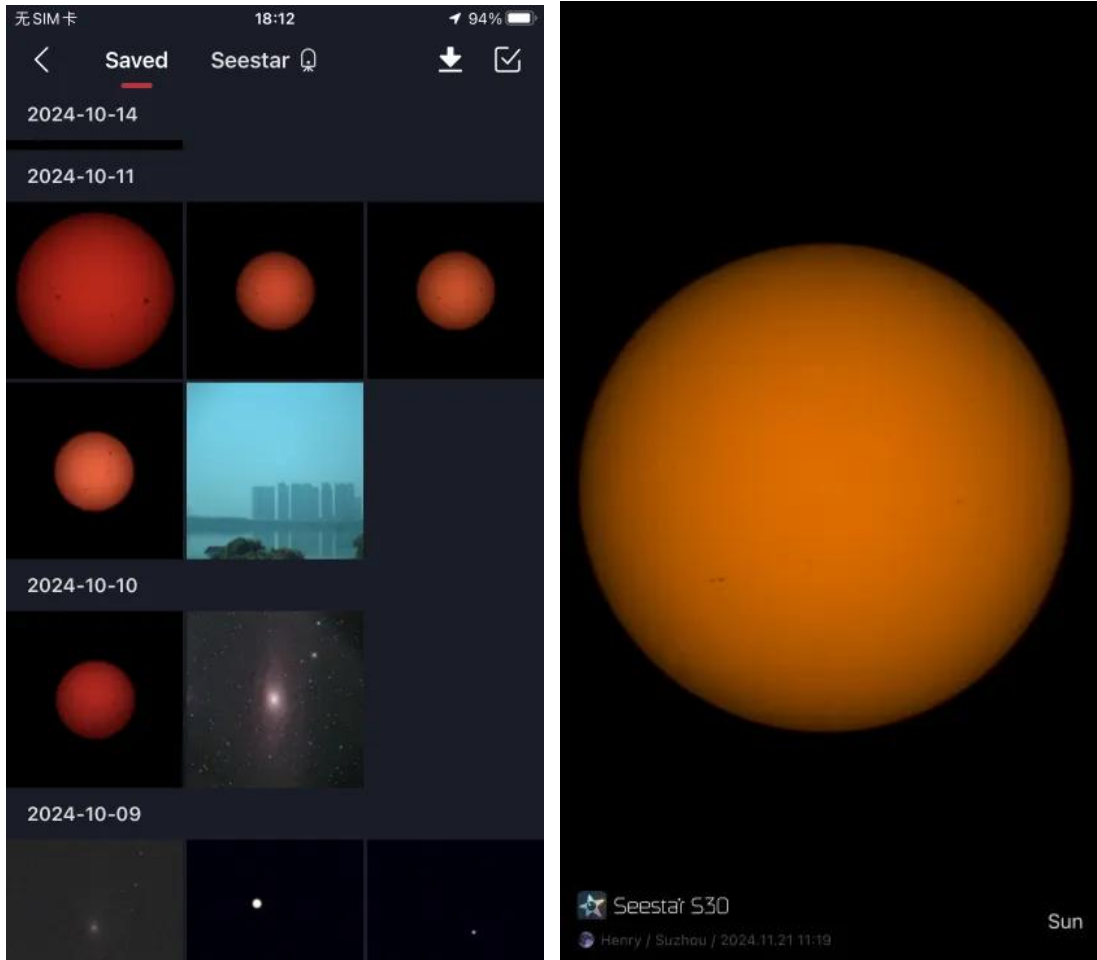

Tap on the photo you've just taken to view it. Then, tap the share icon on the bottom. 

In the pop-up menu, choose to share the photo on social media or export it to other Apps, sharing this special stargazing experience with astronomy enthusiasts worldwide.



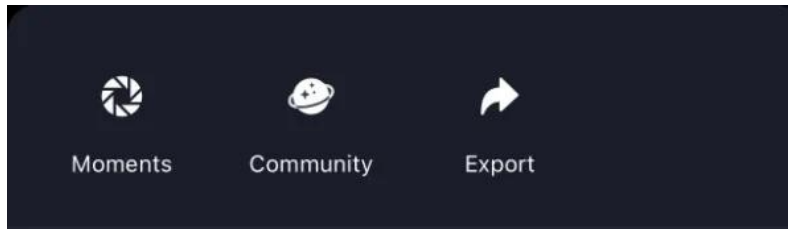

Tip: You can also directly share photos to the in-built community.

Once everything is complete, you can either continue to observe other objects or power down the device and store it properly.

## 2.8 Battery Life

The Seestar S30 has an internal battery that lasts Approximately 6 hours. If you need to extend the battery life, please prepare an additional power source for the device. The Seestar S30 supports working while charging. At home or when you have access to a power outlet, you can connect the Type-C cable to a power adapter or computer that meets the power input specifications. When using the device outdoors, you can carry a portable charger to charge the device as needed.

Note: The battery life is based on test results from ZWO's internal laboratory. Actual usage time may vary depending on the environment and operating conditions of the device.

## 2.9 Power Off and Storage

If you have completed your shooting tasks, please follow the instructions below to power off the device.

- Two methods for normal shutdown:



a. Method 1: In the App, go to the "My" page, and at the bottom, use the swipe-to-shut-down function. The Seestar S30 lens will return to the zero position and then shut down smoothly.

b. Method 2: On the Seestar S30 device, press and hold the power button for 3 seconds. The Seestar S30 lens will return to the zero position and then shut down smoothly.

- Forced shutdown method:

If the device cannot be powered off through the normal shutdown methods, use this forced shutdown method.

On the Seestar S30 device, press and hold the power button for 6 seconds. The Seestar S30 lens will not return to the zero position and will shut down directly.

- Automatic shutdown mechanism:

When the battery level drops below 5%, the device will automatically return to the zero position and shut down.

After powering off, please store the device in a clean and dry place.

### 3. Accessory Installation and Removal

#### 3.1 Installing the Solar Filter

Warning: Do not allow the telescope lens to directly observe the sun!

- While observing the sun, please use the standard solar filter coming with Seestar.

Before entering the Solar System mode in the Seestar App for solar observation, follow the on-screen instructions to attach the magnetic solar filter to the primary mirror position. Then, operate the App to point the telescope at the sun for observation.

- After completing the observation, first adjust the angle of the Seestar S30 lens to ensure the sun is no longer within the field of view of the telescope lens, then remove the solar filter and store it properly.



#### 3.2 Battery Removal

If you need to replace the battery, please follow these steps:

1. Locate the battery compartment on the device body.
2. Use an Appropriate tool (such as a flathead screwdriver) to gently pry open the battery cover.

3. Carefully disconnect the battery terminal.
4. Finally, remove the battery. Please ensure that you handle everything gently throughout the process to avoid damaging the equipment.

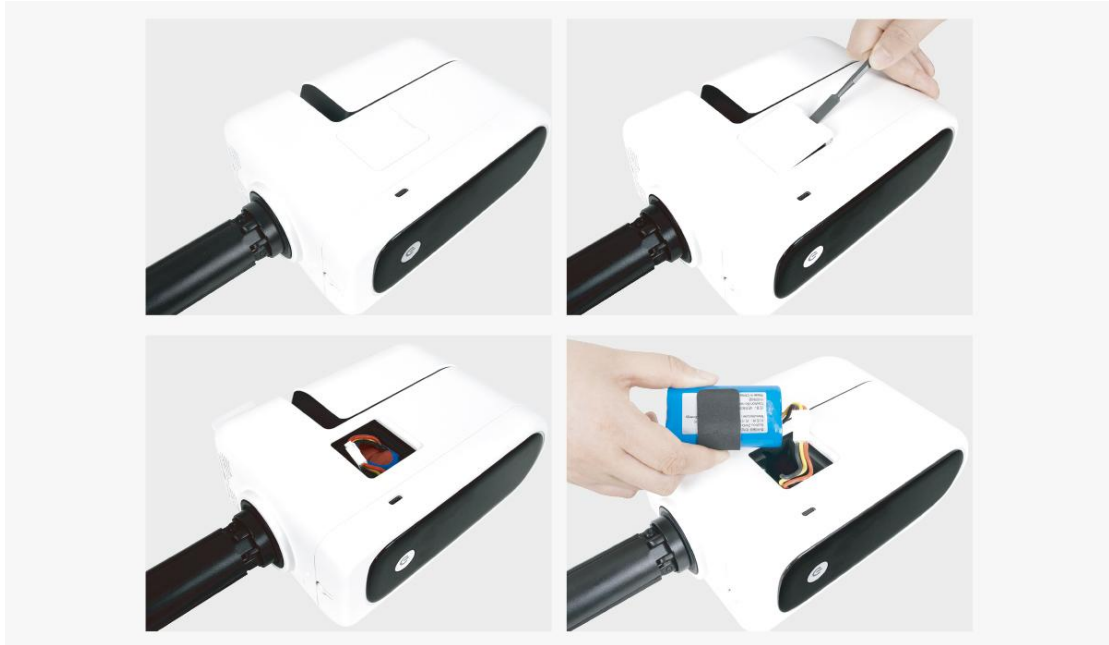

**Precautions:**

1. Before removing the battery, make sure the device is turned off and disconnected from any power source. Also, handle with care to prevent damage to the device or the battery.
2. After removing the old battery, store it safely to avoid short circuits.
3. Do not remove the battery unless you intend to replace it.

## 4. Observation/Photography Tips

- Targets like the Veil Nebula can be very difficult to observe and require extremely dark skies. For beginners, it is recommended to start with brighter deep-sky objects such as M31, M42, and NGC104.

- This product can be used on balconies, in gardens, cities, or rural areas. It is suggested to have at least 45° of unobstructed sky to avoid any surrounding obstacles blocking the view of your observation target.

- Various factors can affect the quality of observations, such as light pollution levels, atmospheric disturbances, and light pollution. To minimize the impact of light pollution, stay away from streetlights, building security lights, or other direct light sources.

- Cloudy and windy weather conditions can also affect observations.

- During photography, avoid walking around the equipment to prevent vibrations that could reduce the success rate of stacking images.

- If the default field of view does not meet your photography needs, you can use the composition function in Sky Atlas to adjust the field of view, allowing for more flexible shooting perspectives.

- If observing from a balcony, courtyard, or another location with Wi-Fi access, you can enable the Station Mode in Seestar S30's network settings and connect it to Wi-Fi. The mobile device used for observation only needs to be on the same local network as the Seestar S30 to establish a connection.

## 5. Structural Dimension Diagram

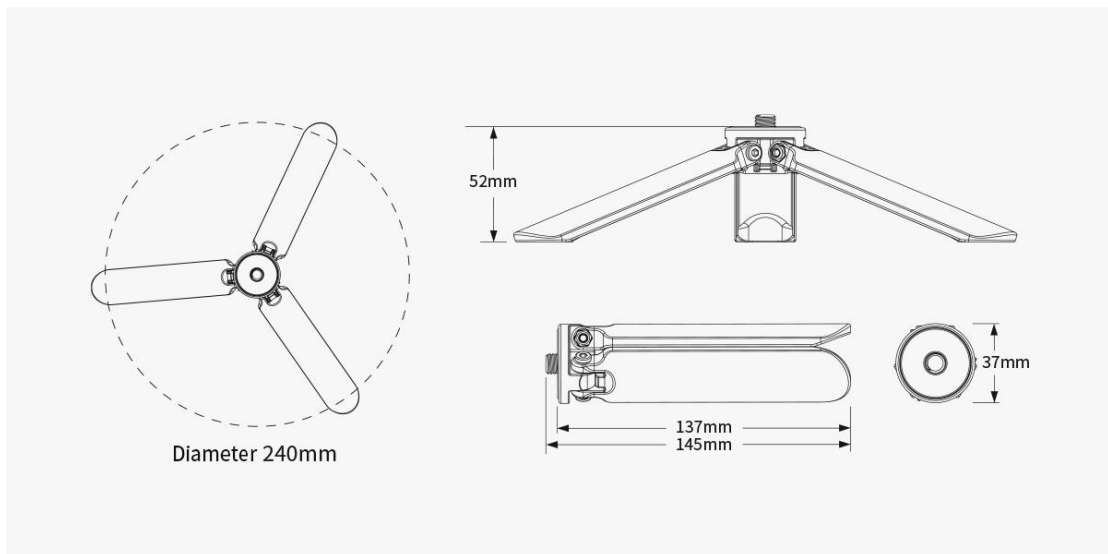
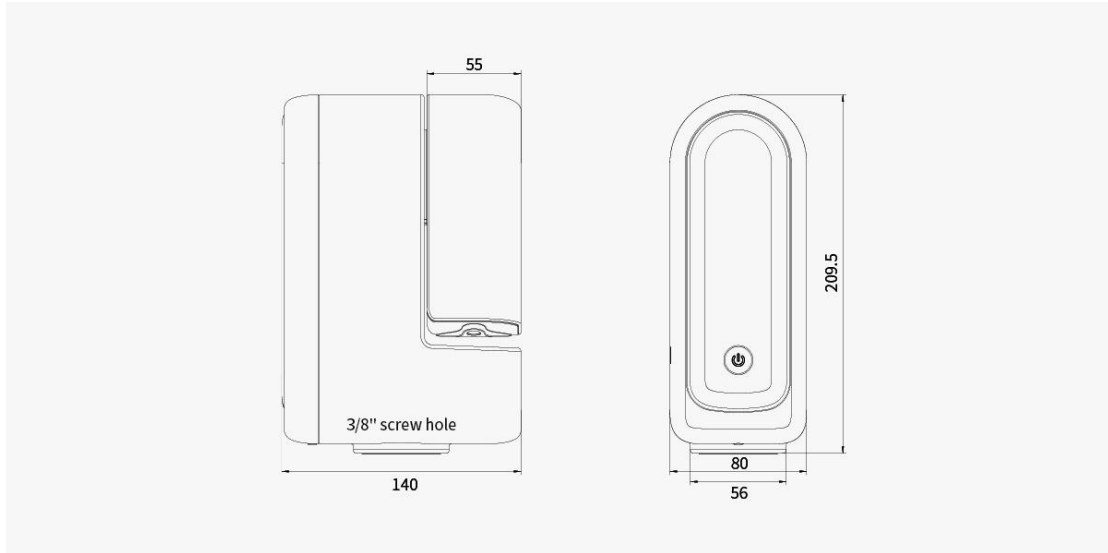

## **6. Disclaimer**

This product is not a toy. Please keep it and any parts or cables out of reach of children. Exercise caution when operating the product in environments where children are present.

Read the entire User Manual and familiarize yourself with the product's features before use. Improper operation of this product may result in damage to the device and property loss.

For more terms of service, please refer to the Service Agreement within the App. ZWO assumes no responsibility for any losses resulting from the improper use of this product against the guidelines outlined in the User Manual.

To the extent permitted by law, ZWO reserves the right of final interpretation of this document. ZWO may update, revise, or discontinue this document without prior notice.

Future product updates and changes will not be announced separately, and ZWO retains the right to make such modifications.

## 7. After-Sales Service

To update your software, please visit the official website at:

<https://www.zwoastro.com/>

Navigate to Support > Guides and Manuals > Seestar to download the latest updates.

For repairs and other Services:

Chinese Users: Follow the ZWO Official WeChat account and send messages to our customer service team.

Overseas Users: Visit the <https://support.zwoastro.com/> page and submit a service ticket.

Email: [info@seestar.com](mailto:info@seestar.com)

Phone: +86 0512-65923102

For products returned or replaced under warranty, customers are responsible for the shipping costs to return the product. When returning the product, you must include a note detailing the actual cause of the issue and provide relevant proof, such as photos or videos.

If ZWO confirms in writing that a replacement is necessary, the user must return the product with all accessories, manuals, and packaging to the address specified by ZWO. By returning the product, you agree to pay for any non-warranty repair fees incurred during the process. The repaired or replaced product will be sent back after payment.

For products requiring return for after-sales service, ZWO will provide an RMA (Return Merchandise Authorization) Code for reference. ZWO will not accept any returns without prior written confirmation and a valid RMA code.

If your Seestar product was purchased through a ZWO authorized dealer, please contact the dealer directly for after-sales support.

## 8. Warranty Policy

1. ZWO offers a 2-year free warranty for products purchased directly from the company, starting from the date of receipt (1-year warranty for the battery).

2. If the user encounters a Dead-on-Arrival (DOA) issue and contacts ZWO within the specified time frame, providing proof of purchase and related documentation, ZWO will arrange for a pickup service and, depending on the situation, offer the following services: replacement (or partial replacement), repair, or refund (or partial refund).

1) Product Quality Issues: If a quality issue is identified within 30 days of receipt and confirmed by ZWO's Customer Service Center, ZWO will provide free replacement.

2) Shipping Issues: If the product packaging shows clear signs of water damage, severe compression, or deformation upon receipt, and the user provides packaging photos and proof of receipt within 3 days, ZWO will verify and offer refund or replacement for items shipped directly by ZWO or its authorized distributor. If the shipment is handled directly by the dealer, the dealer will be responsible for after-sales support.

3. The following circumstances are not covered under the warranty, but ZWO can offer repair services:

1) The product is out of warranty.

2) The product has liquid ingress, moisture damage, or corrosion.

3) Damage caused by external forces, such as scratches, deformed casing, or broken Type-C ports.

4) Unauthorized disassembly, third-party repairs, modification, firmware flashing, or installation of incorrect firmware.

5) Alteration of the system or removal/modification of warranty seals.

6) Improper installation or use contrary to the product manual.



7) Damage due to force majeure events such as floods, fires, earthquakes, lightning, or severe impact.

8) User errors during operation or usage that result in damage.

9) Lack of valid proof of purchase or warranty certificate.

10) The product is a second-hand item.

Accessories or other components with quality issues are not grounds for returning or replacing the main device. Users can request replacement of the affected accessory separately.

Note: Any updates or modifications to this document are subject to change without prior notice.